



BRILONER[®]

Light. Inspired by life.

2025

HERZLICH WILLKOMMEN!

WELCOME!
BIENVENUE À TOUS!

LIGHTROOM

AUGENÖFFNENDE KOMMUNIKATION

Licht und seine Anwendung ist ein komplexes Thema. Mit den richtigen Tipps und Anwendungshinweisen nimmt es jedoch massiv positiven Einfluss auf das Zuhause und macht unglaublich Spaß. Diesen haben wir unseren Endkunden in zehn wegweisenden Filmen verpackt - viel Spaß beim Anschauen!

EYE-OPENING COMMUNICATION

Light and its application is a complex matter. However, it can have a far-reaching, positive effect on a home with the right tips and instructions, whilst also being a great deal of fun. We have covered this for our end customers in ten ground-breaking films - enjoy watching them!

ANNONCE POUR VOUS OUVRIR LES YEUX

Les éclairages et leur utilisation peuvent apparaître complexes. Avec les bonnes astuces et bons conseils d'utilisation, ils peuvent toutefois avoir un impact positif sur votre maison et se révéler très plaisants. Nous avons résumé tout cela en dix films innovants pour nos clients - Bon visionnage !



GEMEINSAM

für ein lebenswertes Morgen

*Coming together for a tomorrow worth living for
Ensemble pour un avenir sain*

DE

Wir übernehmen Verantwortung und setzen uns in den kommenden Jahren verstärkt für den Fortbestand unserer Umwelt ein. Getreu dem Motto: Heute für ein lebenswertes Morgen. Was bedeutet das konkret? Wir möchten unseren Beitrag leisten, um die Klimaziele der EU und der Vereinten Nationen bestmöglich zu unterstützen. Deshalb leiten wir notwendige Maßnahmen ein, um unsere CO₂-Bilanz kontinuierlich zu optimieren um so früh wie möglich unser Ziel

„Klimaneutralität für die gesamte BRILONER Gruppe“ zu erreichen. Das betrifft nicht nur unsere Produkte und deren Distributionszyklus.

GB

We are taking responsibility and in the coming years will be increasingly committed to the continued existence of our environment. True to the motto: Today for a tomorrow worth living. What does that mean in concrete terms? We want to do our part to support the climate goals of the EU and the United Nations in the best possible way. That is why we are taking the necessary measures to continuously optimize our CO₂ balance in order to achieve our goal of „climate neutrality for the entire BRILONER Group“ as early as possible. This does not only apply to our products and their distribution cycle.

FR

Nous prenons nos responsabilités et nous nous engageons davantage pour la pérennité de notre environnement dans les années à venir. Fidèle à notre devise : aujourd'hui pour un demain qui vaut la peine d'être vécu. Qu'est-ce que cela signifie concrètement ? Nous souhaitons apporter notre contribution pour soutenir au mieux les objectifs climatiques de l'UE et des Nations unies. C'est pourquoi nous prenons les mesures nécessaires pour optimiser en permanence notre bilan CO₂ afin d'atteindre le plus tôt possible notre objectif de „neutralité climatique pour l'ensemble du groupe BRILONER“. Cela ne concerne pas seulement nos produits et leur cycle de distribution.



UMWELT MANAGEMENT

DE

Wir bei BRILONER sind überzeugt, dass Produktivität und Umweltbewusstsein in einer gelebten Symbiose in Einklang gebracht werden können und haben uns als einer der Ersten dazu entschieden, ein Umweltmanagementsystem nach dem internationalgültigen Standard der ISO 14001 zu etablieren, welches 2022 erfolgreich zertifiziert worden ist.

GB

At BRILONER, we are convinced that productivity and environmental awareness can be harmonized in a lived symbiosis and were one of the first to decide to establish an environmental management system in accordance with the internationally valid ISO 14001 standard, which was successfully certified in 2022.

FR

Chez BRILONER, nous sommes convaincus que la productivité et le respect de l'environnement peuvent être conciliés dans une symbiose vécue et nous avons été parmi les premiers à décider d'établir un système de gestion de l'environnement selon la norme internationale ISO 14001, qui a été certifiée avec succès en 2022.



AKTIVES UMWELT MANAGEMENT

Klimaschutz als Produktstrategie

Mehr als 70 % unserer Produkte beleuchten Ihr Zuhause durch reine LED-Technik. 100 % sind LED-gesegnet.

Verpackungskonzept

Wir lösen 2 Millionen Blister durch Kartonverpackungen ab. Beim Versandschutz von Europaletten mit Ware und Warenträgern stellen wir von Folie auf Überkartons um. Weniger ist Pappe!

Aktionen mit Mehrwert

Unsere Displays bauen wir aus Pappe oder Holz und nutzen sie mehrfach. So generieren wir einen maximalen Lebenszyklus. Dabei sparen wir 30 % Logistikaufwand und 70 % Material ein – so lohnt sich eine Aktion für den Kunden auch für die Umwelt. Ein Joint Venture mit der Natur!

Energiemanagement

Unsere Reisetätigkeiten konnten wir durch ein ausgeweitetes Home-officekonzept maßgeblich reduzieren. Meetings finden digital statt. Der Anteil an Hybridfahrzeugen im Fuhrpark wächst exponentiell. Nachhaltiges Handeln fängt bei jedem an!

Das grüne Logistikzentrum

Ist schwarz und steht in Enste. Hier haben wir 2019 unter ökologischen Gesichtspunkten neu gebaut. Unter Berücksichtigung eines durchdachten Beheizungskonzepts, effizienter Beleuchtung und vieler weiterer, nachhaltiger Aspekte ist uns ein grüner Paukenschlag gelungen. Briloner goes green!

CONTRIBUTION TO A GREENER FUTURE

Climate protection as a product strategy

More than 70 % of our products light up your home with pure LED technology. 100 % are LED-suitable.

Packaging concept

We are replacing 2 million blister packs with carton packaging. For shipping protection of Euro pallets with goods and goods carriers, we are switching from foil to overcartons. Less is carton!

Promotions with added value

We build our displays from wood or carton and use them several times. This way we generate a maximum life cycle. In doing so, we save 30 % in logistics costs and 70 % in materials - so a promotion for the customer is also worthwhile for the environment. A joint venture with nature!

Energy management

We have been able to significantly reduce our travel activities through an expanded home office concept. Meetings take place digitally. The proportion of hybrid vehicles in our fleet is growing exponentially. Sustainable action starts with everyone!

The green logistics centre

is black and is located in Enste. Here, we have rebuilt in 2019 with ecological aspects in mind. Taking into account a well-thought-out heating concept, efficient lighting and many other sustainable aspects, we have succeeded in creating a green drumbeat. Briloner goes green!

CONTRIBUTION À UN AVENIR PLUS VERT

La protection du climat comme stratégie produit

Plus de 70 % de nos produits illuminent votre maison avec de l'énergie LED pure. 100 % sont LED ou compatibles LED.

Concept d'emballage

Nous remplaçons 2 millions de blisters par des emballages en carton. Pour la protection de l'expédition de marchandises sur europalettes, nous passons du plastique à bulles au carton. Le carton c'est mieux !

Promotions à valeur ajoutée

Nous construisons nos présentoirs en bois ou en carton et les réutilisons plusieurs fois. De cette façon, nous générons un cycle de vie maximal. Ce faisant, nous économisons 30 % d'efforts logistiques et 70 % de matériaux. Une promotion pour le client est donc également respectueuse de l'environnement. Un projet commun avec la nature !

Gestion de l'énergie

Nous avons pu réduire considérablement nos activités de déplacement grâce à un concept de bureau à domicile élargi. Les réunions se déroulent sous forme numérique. La proportion de véhicules hybrides dans notre flotte augmente de manière exponentielle. L'action durable commence avec tout le monde !

Le centre logistique vert

est noir et se trouve à Enste. Ici, nous avons reconstruit en 2019 en tenant compte des aspects écologiques. En tenant compte d'un concept de chauffage bien pensé, d'un éclairage efficace et de bien d'autres aspects durables, nous avons réussi à créer un bâtiment vert. Briloner se met au vert !

EDITORIAL



FINALLY!

Mit unserem Logistikzentrum am Standort Meschede-Enste sind wir 2019 einen 20.000 qm großen Schritt gegangen, um Euch noch agiler mit den Lichtkonzepten von Morgen zu versorgen. 2021 wurden weitere 5000 qm Fläche in Enste angebaut und bezogen, um unseren Ladenbau noch effizienter zu machen und den stationären Handel mit einer rasanten Reaktionsgeschwindigkeit zu berauschen. Inzwischen ist auch der lange angekündigte, letzte Schritt getan: der Umzug unserer Verwaltung. 260 Kolleginnen und Kollegen haben ihren neuen Arbeitsplatz auf der 6.000 qm Büro- und Ausstellungsfläche bezogen, die man knapp mit drei Worten beschreiben kann: hochmodern, ökologisch und innovativ. Tschüss & Danke Brilon, it was a blast.

FÜNF
TAUSEND M²
BÜROFLÄCHEN

24.000 M²
LOGISTIK- UND
SUPPORTFLÄCHEN

2 000 M² AUSSTELLUNG- UND
SHOWROOMFLÄCHEN

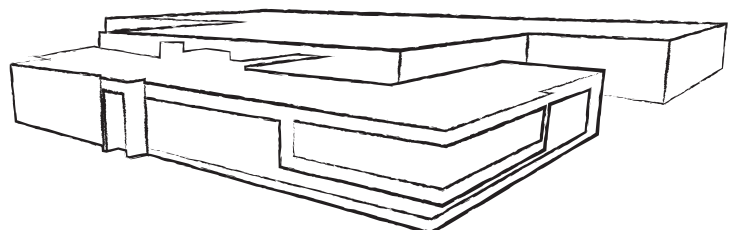

FINALLY!

In 2019, we took a 20,000 m² step by building our logistics centre at the Meschede-Enste site to provide you with the lighting concepts of tomorrow in an even more agile way. In 2021, another 5,000 m² of space was added in Enste to make our shopfitting even more efficient and to dazzle bricks-and-mortar retailers with a rapid response speed. And now the long awaited final step has been taken: the relocation of our administration team. 260 staff members have moved into their new workspace in the 6,000 m² office and exhibition area, which can be succinctly described as state-of-the-art, ecological and innovative. Thanks & goodbye Briloner, it was a blast.

ENFIN!

Notre centre logistique de Meschede-Enste a dépassé les 20 000 m² en 2019 pour vous fournir de manière encore plus agile les concepts d'éclairage de demain. En 2021, 5000 m² de surface supplémentaire ont été ajoutés et aménagés à Enste, afin de rendre notre magasin encore plus efficace et de réagir plus rapidement. Aujourd'hui, la dernière étape tant annoncée a également été franchie : le déménagement de notre administration. 260 collègues se sont installés dans leurs nouveaux postes de travail dans les 6000 m² de bureaux et d'espaces d'exposition, que l'on peut décrire en trois mots : ultramoderne, écologique et innovant. Au revoir et merci Briloner, c'était génial.



INHALTSVERZEICHNIS

TABLE OF CONTENT | TABLE DES MATIÈRES

10 PIMP YOUR PANEL

24 AUSSENBELEUCHTUNG
*ACCULUTURES
ACCULUTIONS*

38 CONNECT TO SHINE

56 PIMP YOUR STRIPE

74 EINBAULEUCHTEN
*RECESSES LUMINAIRES
LUMINAIRES ENCASTRABLES*

130 BADEZIMMER
*BATHROOM
SALLE DE BAIN*





10 PIMP YOUR PANEL



212 FRAMES



230 LOFT

174 FUNKTIONALES LICHT
*FUNCTIONAL LIGHTING
ÉCLAIRAGE FONCTIONNEL*

212 FRAMES

230 LOFT

264 DECKENLEUCHTEN
*CEILING LIGHTS
PLAFONNIERS*

290 SPOTS

A person is sitting on a light grey sofa in a modern living room. Their legs are propped up on two large, brown cardboard boxes. They are wearing blue jeans and white socks. The background wall is made of vertical wooden slats. The floor is light-colored wood. The text "10 PIMP YOUR PANEL" is overlaid in the center of the image.

10 PIMP YOUR PANEL

PIMP |||||
YOUR PANEL



PIMP |||||
YOUR PANEL

DESIGN TRIFFT FUNKTION

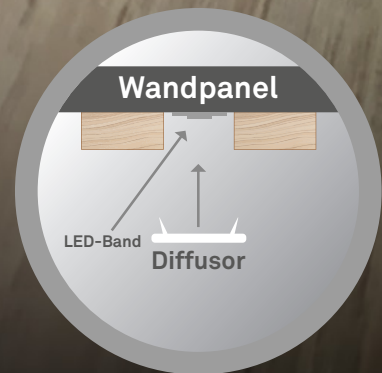

LICHT UND AKUSTIK
IN STRAHLENDER
HARMONIE

IN 5 SCHRITTEN ZUM INDIVIDUELLEN PANEL



PIMP YOUR PANEL - BRINGEN SIE LICHT INS DUNKEL!

Entdecken Sie das revolutionäre Lichtleistsystem Pimp Your Panel und verwandeln Sie Ihre Akustikpaneele in beeindruckende Lichtquellen! Speziell entwickelt, um LED-Leuchtstreifen in die Zwischenräume von Akustikpaneele zu integrieren, bietet unser System eine perfekte Kombination aus Funktionalität und Ästhetik.

WARUM PIMP YOUR PANEL?

- 1. ELEGANTES DESIGN:** Unsere transparenten Diffusor-Leisten sorgen für eine gleichmäßige Lichtverteilung und verleihen Ihren Räumen eine moderne und stilvolle Atmosphäre. Durch die unauffällige Integration der LED-Leuchtstreifen bleibt das Design Ihrer Akustikpaneele im Vordergrund.
- 2. EINFACHE INSTALLATION:** Pimp Your Panel ist benutzerfreundlich und lässt sich mühelos in Ihre bestehenden Akustikpaneele integrieren.
- 3. OPTIMALE AKUSTIK UND BELEUCHTUNG:** Unsere Lösung beeinträchtigt die akustische Wirkung Ihrer Paneele kaum. Genießen Sie weiterhin eine hervorragende Schallabsorption, während Sie gleichzeitig Ihre Räume optimal ausleuchten.
- 4. ENERGIEEFFIZIENZ:** Die LED-Technologie von Pimp Your Panel ist nicht nur langlebig, sondern auch energieeffizient. Reduzieren Sie Ihre Stromkosten und profitieren Sie von einer nachhaltigen Beleuchtungslösung.

EN

Pimp Your Panel offers a revolutionary light strip system that allows you to transform your acoustic panels into impressive light sources. The system is designed to integrate LED light strips between the panels, providing both functionality and aesthetics. The transparent diffuser strips ensure an even distribution of light, creating a modern and stylish atmosphere in your rooms. The installation is easy, allowing for a user-friendly integration into your existing panels. Despite the addition of the light strips, the system does not significantly affect the acoustic effect of the panels, allowing you to continue enjoying excellent sound absorption. In addition, the LED technology used in Pimp Your Panel is durable and energy-efficient, helping you reduce electricity costs and providing a sustainable lighting solution.

FR

Découvrez le système Pimp Your Panel qui permet d'intégrer des bandes lumineuses LED dans les panneaux acoustiques, offrant ainsi une combinaison idéale entre fonctionnalité et esthétique. Les bandes de diffusion transparentes garantissent une répartition uniforme de la lumière et donnent aux pièces une atmosphère moderne et stylée tout en mettant en valeur le design des panneaux acoustiques. Pimp Your Panel s'intègre facilement dans les panneaux existants, sans compromettre l'effet acoustique. Vous pourrez ainsi bénéficier d'une excellente absorption acoustique tout en éclairant vos pièces de manière optimale. De plus, cette solution est économe en énergie grâce à la technologie LED, ce qui vous permettra de réduire vos coûts d'électricité tout en profitant d'un éclairage durable. Ajoutez de la lumière à l'obscurité et transformez vos panneaux acoustiques en sources de lumière impressionnantes avec Pimp Your Panel.

PIMP |||||
YOUR PANEL



INDIVIDUELLE LICHTGESTALTUNG

Die LED-Bänder lassen sich flexibel an den Akustikpaneelen positionieren.

UNIVERSELL EINSETZBAR

Diffusor zum Einsetzen in alle handelsüblichen Akustikpaneelen

ULTRAFLACHE KABEL

Kabel können unkompliziert hinter dem Panel verlegt werden.

INDIVIDUELL KÜRZBAR

Die Diffusoren & LED-Bänder können individuell gekürzt werden.

ERWEITERBAR

Basic-Sets mit bis zu 3 weiteren Extension-Sets erweiterbar.

PLUG & PLAY

Unkomplizierte Zusammenstellung des Systems durch Steckverbindungen.



DIFFUSOR



8043005

1

schwarz/black/noir
12-13mm

4002707475576

8043006

2

weiß/white/blanc
12-13mm

4002707475545

1,3
m





DIFFUSOR EINFACH IN DIE ZWISCHENRÄUME DER AKUSTIKPANELEELE KLEMMEN

EN SIMPLY CLIP THE DIFFUSER BETWEEN THE ACOUSTIC PANEL

FR DIFFUSEUR SIMPLEMENT INSÉRÉ ENTRE IN ENCLENCHER LE PANNEAU ACOUSTIQUE



Kürzbar
Can be shortened
Peut être raccourci

14-15mm

14-15mm

4



1,3
m



3

8024006

weiß/white/blanc
14-15mm

4002707461487

4

8024005

schwarz/black/noir
14-15mm

4002707461494

BASIC-SET

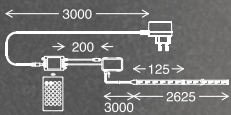
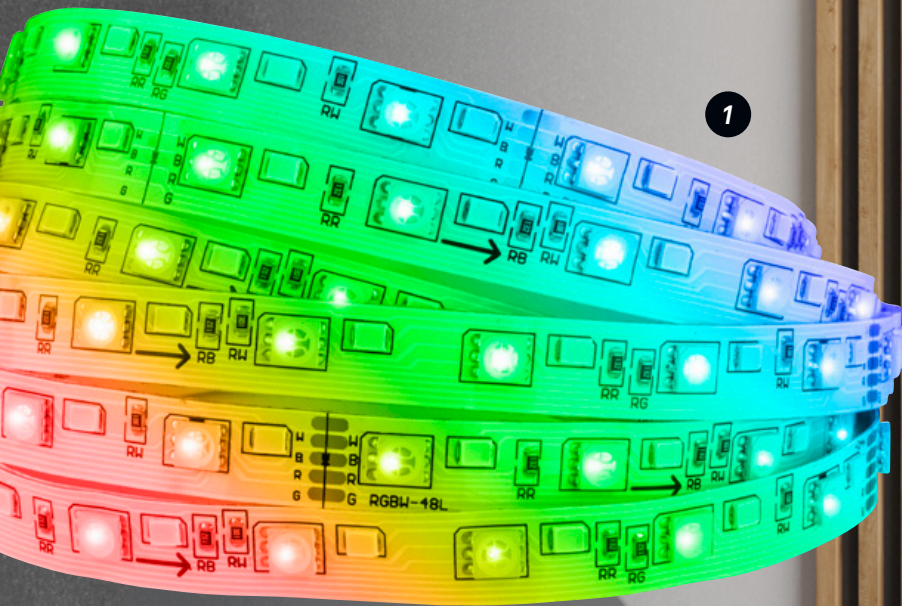

- INKL. 3M ZULEITUNG
- INKL. CONNECTOR-BOX
- SELBSTKLEBEND
- ERWEITERBAR AUF MAX. 10M
(Erweiterungs-Set siehe rechte Seite)

802252

1

weiß/white/blanc

inkl. 252x LED 650lm
3.000K
4002707462729

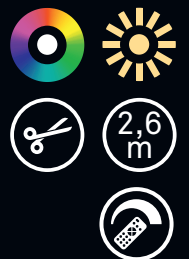

PIMP YOUR PANEL

- SELBSTKLEBEND
- BETRIEB NUR IN VERBINDUNG MIT BASIC-SET (siehe linke Seite)

2

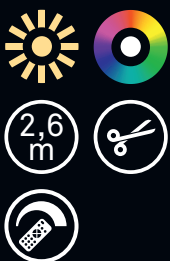
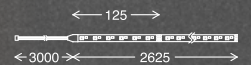

2

8023252

weiß/white/blanc

inkl. 252x LED 650 lm
3.000 K
4002707462828

BASIC-SET

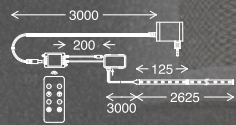

- INKL. 3M ZULEITUNG
- INKL. CONNECTOR-BOX
- SELBSTKLEBEND
- ERWEITERBAR AUF MAX. 10M
(Erweiterungs-Set siehe rechte Seite)

8020294

1

weiß/white/blanc

inkl. 294x LED 1.300lm
3.000 - 6.500 K
4002707462712



2,6
m



PIMP YOUR PANEL

- SELBSTKLEBEND
- BETRIEB NUR IN VERBINDUNG MIT BASIC-SET (siehe linke Seite)

2

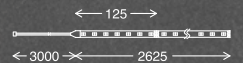

2,6
m



2

8021294

weiß/white/blanc

inkl. 294x LED 1.300 lm
3.000 - 6.500 K
4002707462835

BASIC-SET

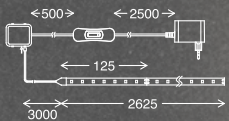
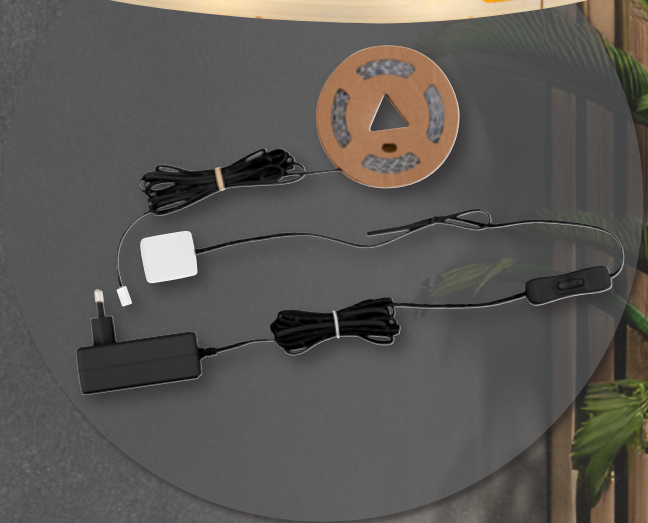

- INKL. 3M ZULEITUNG
- INKL. CONNECTOR-BOX
- SELBSTKLEBEND
- ERWEITERBAR AUF MAX. 10M
(Erweiterungs-Set siehe rechte Seite)

8018147

1

weiß/white/blanc

inkl. 147x LED 1.300lm
3.000K
4002707462705



2,6
m



PIMP YOUR PANEL

- SELBSTKLEBEND
- BETRIEB NUR IN VERBINDUNG MIT BASIC-SET (siehe linke Seite)



2



2,6
m



2

8019147

weiß/white/blanc

inkl. 147x LED 1.300 lm
3.000 K
4002707462811

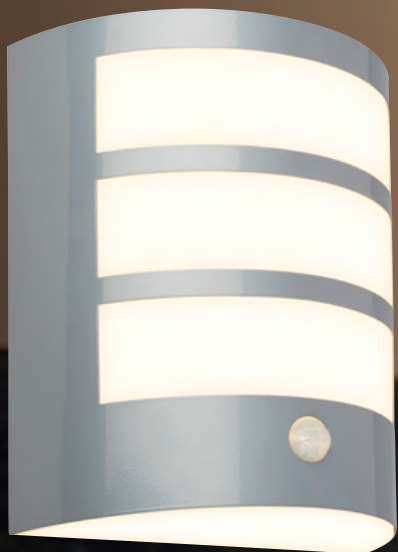

unplugged

24

AUSSENLEUCHTEN

ACCULUTURES | ACCULUTIONS





BELEUCHTEN SIE IHREN AUSSENBEREICH – KABELLOS, STILVOLL UND EFFIZIENT!

Unsere Akku-Außenwandleuchten vereinen modernste Technologie mit elegantem Design und bieten flexible, umweltfreundliche Beleuchtungslösungen für Garten, Terrasse und Balkon.

Entdecken Sie die Vielseitigkeit und Eleganz unserer Akku-Außenwandleuchten! Diese innovative Beleuchtungslösung vereint modernste Technologie mit stilvollem Design und sorgt für stimmungsvolle Akzente in Ihrem Außenbereich. Ohne lästiges Kabelwarr und mit langer Akkulaufzeit sind unsere Wandleuchten nicht nur flexibel einsetzbar, sondern auch umweltfreundlich und energieeffizient. Ideal für Garten, Terrasse oder Balkon – setzen Sie auf Qualität und zeitgemäße Beleuchtung mit unseren Akku-Außenwandleuchten. Sorgen Sie für eine einladende Atmosphäre rund um Ihr Zuhause, ganz ohne Aufwand!

EN

Discover the versatility and elegance of our rechargeable outdoor wall lights! This innovative lighting solution combines state-of-the-art technology with stylish design and creates atmospheric accents in your outdoor area. Without the hassle of tangled cables and with a long battery life, our wall lights are not only flexible to use but also environmentally friendly and energy-efficient. Ideal for the garden, patio or balcony - rely on quality and contemporary lighting with our rechargeable outdoor wall lights. Create an inviting atmosphere around your home without any effort!

FR

Découvrez la polyvalence et l'élégance de nos appliques murales d'extérieur à batterie ! Cette solution d'éclairage innovante allie une technologie de pointe à un design élégant et apporte une touche d'ambiance à votre espace extérieur. Sans câble encombrant et avec une longue durée de vie de la batterie, nos appliques murales ne sont pas seulement flexibles dans leur utilisation, mais aussi écologiques et efficaces sur le plan énergétique. Idéales pour le jardin, la terrasse ou le balcon, misez sur la qualité et l'éclairage contemporain avec nos appliques murales d'extérieur à batterie. Créez une atmosphère accueillante autour de votre maison, sans effort!



TIME TO BE unplugged

MACHT JEDEN ORT EIN
STÜCK GEMÜTLICHER. EGAL
OB WOHNZIMMER, LESECKE,
IM GARTEN ODER BEIM PICKNICK.



OHNE STECKDOSE

AKKU EINFACH VIA
USB-C AUFLADEN UND
LEUCHTE ÜBERALL
DORT EINSETZEN,
WO ES KEINE
STECKDOSE GIBT.



MAXIMAL EFFIZIENT

- RECYCELBAR
- ENERGIESPAREND
- LANGLEBIG
- AKKU UND PLATINE
AUSTAUSCHBAR



AUSSEERGEWÖHNLICH KABELLOS KOMFORTABEL UMWELTFREUNDLICH

MODERN & EFFIZIENT

MODERN & EFFICIENT
MODERNE & EFFICACE

DE

- DIMMBAR
- USB-C PORT ZUM
EINFACHEN AUFLADEN
- SCHUTZART IP44

EN

- DIMMABLE
- USB PORT FOR EASY
CHARGING
- IP44 PROTECTION CLASS

FR

- VARIATEUR D'INTENSITÉ
- PORT USB POUR
FACILE À RECHARGER
- CLASSE DE PROTECTION
IP44



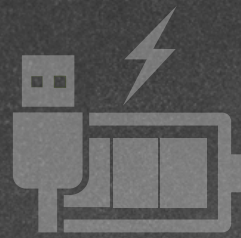

AKKU LED

OHNE STECKDOSE

WITHOUT POWER SOCKET
SANS PRISE ÉLECTRIQUE

AKKU EINFACH VIA USB-C AUFLADEN UND LEUCHE ÜBERALL DORT EINSETZEN, WO ES KEINE STECKDOSE GIBT.

EN
SIMPLY CHARGE THE BATTERY VIA USB C AND USE THE LIGHT ANYWHERE, WHERE THERE IS NO POWER SOCKET.

FR
RECHARGER SIMPLEMENT LA BATTERIE VIA USB C ET UTILISER LA LAMPE PARTOUT, LÀ OÙ IL N'Y A PAS DE PRISE DE COURANT.

NACHHALTIG

SUSTAINABLE
DURABLE

DE
AUSTAUSCHBARE AKKUS UND PLATINEN FÜR EINE GRÜNE ZUKUNFT

EN
REPLACEABLE BATTERIES AND CIRCUIT BOARDS FOR A GREEN FUTURE

FR
DES BATTERIES ET DES CARTES ÉLECTRONIQUES INTERCHANGEABLES POUR UN AVENIR VERT

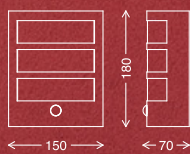

3795014

1

chrom/chrome/chrome

inkl. LED/5,8 W 700 lm
3.000 K
4002707455196

3795015

2

schwarz/black/noir

inkl. LED/5,8 W 700 lm
3.000 K
4002707455189



AKKULED



3

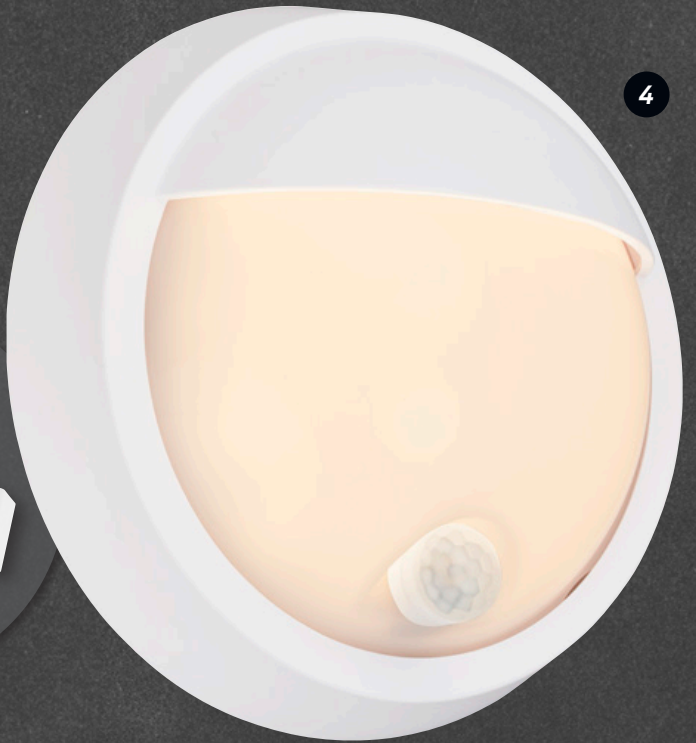
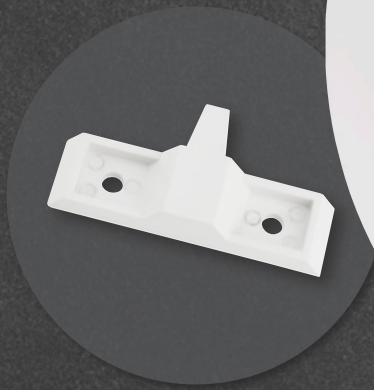
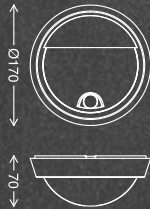

4



3

3785015

schwarz/black/noir
inkl. LED 4 W/ 700 lm
3.000 K
4002707447306

4

3785378016

weiß/white/blanc
inkl. LED 4 W/ 700 lm
3.000 K
4002707447320

1

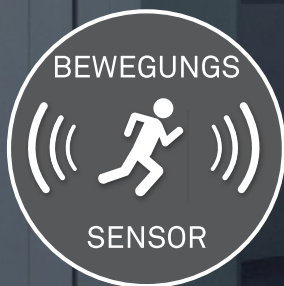
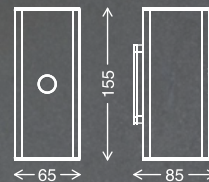

2



3788015

1

schwarz/black/noir
inkl. LED/6W 700 lm
3.000 K
4002707447375

3788016

2

weiß/white/blanc
inkl. LED/6W 700 lm
3.000 K
4002707447382





3



4

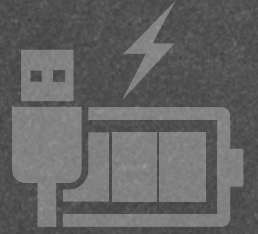
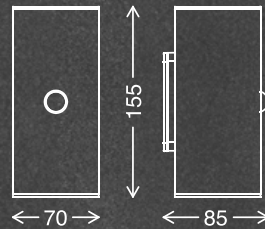

AKKULIED



3

3787015

schwarz/black/noir
inkl. LED 6W/ 700lm
3.000K
4002707447351

4

3787016

weiß/white/blanc
inkl. LED 6W/ 700lm
3.000K
4002707447368

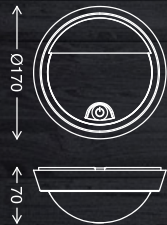

3784015

1

schwarz/black/noir

*inkl. LED/4 W 700 lm
3.000 K
4002707447283*

3784016

2

weiß/white/blanc

*inkl. LED/4 W 700 lm
3.000 K
4002707447290*



AKKU LED

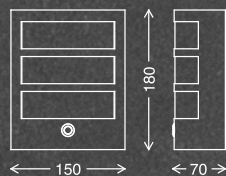
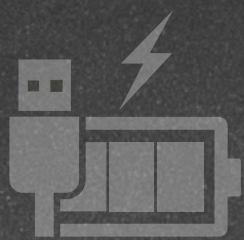

3



4



3

3793014

chrom/chrome/chrome
inkl. LED 5,8W/ 700lm
3.000K
4002707455219

4

3793015

schwarz/black/noir
inkl. LED 5,8W/ 700lm
3.000K
4002707455202



3786015

1

schwarz/black/noir

*inkl. LED/6 W 700 lm
3.000 K
4002707447337*

3786016

2

weiß/white/blanc

*inkl. LED/6 W 700 lm
3.000 K
4002707447344*

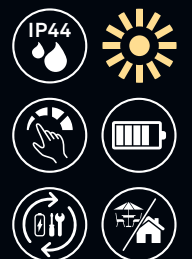

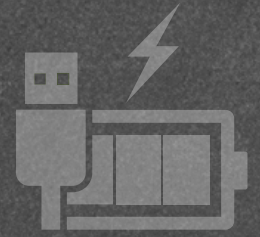
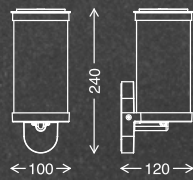
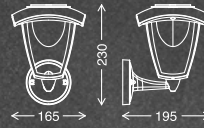

AKKULED

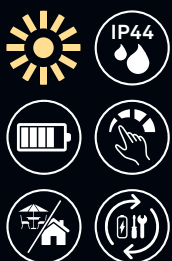

3

3929015

schwarz/black/noir
inkl. LED 4 W/ 400 lm
3.000 K
4002707455554

4

3930015

schwarz/black/noir
inkl. LED 4 W/ 400 lm
3.000 K
4002707455561

CONNECT
TO SHINE

38
CONNECT TO SHINE







**CONNECT
TO SHINE**
BY **BRILONER**

PRODUKTWELT
ENTDECKEN



MASSGESCHNEIDERTE LICHTLÖSUNGEN FÜR IHREN GARTEN

Individuell, einfach und sicher für Mensch und Tier –
das ist CONNECT TO SHINE!

Sie sind auf der Suche nach der idealen Gartenbeleuchtung?
Dann sind die Produkte von CONNECT TO SHINE genau das richtige für Sie.



VIelfÄLTIGE KOMBINATIONSMÖGLICHKEITEN

WIDE RANGE OF POSSIBLE COMBINATIONS
DE MULTIPLES POSSIBILITÉS DE COMBINAISON



ALS ERDSPIESS- UND BODEN- EINBAULEUCHE ERHÄLTlich

E AVAILABLE AS SPIKE AND GROUND-RECESSED LUMINAIRE

FR DISPONIBLE EN TANT QUE LUMINAIRE À PIQUE OU ENCASTRÉ DANS LE SOL



VIelfÄLTIGES ZUBEHÖR

E WIDE RANGE OF ACCESSORIES
FR ACCESSOIRES VARIÉS

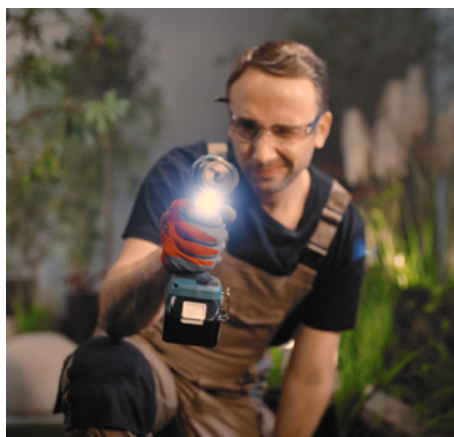

EINFACHE MONTAGE

E SIMPLE ASSEMBLY
FR MONTAGE FACILE



STARTER- UND ERGÄNZUNGSSETS

E STARTER AND EXTENSION SETS

FR KITS DE DÉMARRAGE ET DE COMPLÉMENT

ZUSAMMENSTECKEN. FERTIG. LICHT.

CONNECT TO SHINE

BY **BRILONER**[®]



Liebings-Leuchten
im Garten platzieren.



Durch Zusammen-
stecken verbinden.



In die Steckdose.
Fertig. Licht!



Höchste Sicherheit
durch 12V-System



Wetterbeständig:
IP44 – IP67



*Vielfältiges Zubehör für
vielfältige Möglichkeiten*





1 • BASIC- UND ERGÄNZUNGSSETS FREI KOMBINIERBAR

Beleuchten Sie Terrasse und Garten mit einem System:
Zum Beispiel Basic-Set mit Einbauleuchten in die Terrasse integrieren und mit Erspieß-Ergänzungsset im Blumenbeet erweitern

• KEIN LÄSTIGES AN- UND AUSSCHALTEN

Erweiterbar mit Dämmerungssensor für die einfache Steuerung durch Tageslicht

• FLEXIBEL ERWEITERBAR

Dank verschiedener Kabelsets erweiterbar bis zu max. Leistung des Trafos und 15 Meter Gesamtlänge

2 • WEG- UND AKZENT-BELEUCHTUNG

Beleuchten Sie Wege und setzen Sie einzelne Pflanzen gekonnt in Szene

• T-VERBINDER

Passen Sie das System individuell Ihrem Garten an, indem Sie mit T-Verbindern einfach die Richtung wechseln (mehrere Kabelstränge möglich – je max. 15 Meter vom Trafo bis zur letzten Leuchte)

EN

- **BASIC AND SUPPLEMENTARY SETS**
freely combinable illuminate your patio and garden with one system:
For example, integrate the Basic set with recessed lights in the terrace and extend it with a spike extension set in the flower bed
- **NO ANNOYING SWITCHING ON AND OFF**
switching on and off can be extended with a twilight sensor for simple daylight control
- **FLEXIBLE EXPANSION OPTIONS**
Can be extended thanks to various cable sets up to max. power of the transformer and 15 meters total length

- **PATH AND ACCENT LIGHTING**
illuminate paths and skillfully individual plants
- **T-CONNECTORS**
Adapt the system individually to your garden by simply changing the direction with T-connectors (several cable strands possible - max. 15 meters each from the transformer to the last light)

FR

- **SETS BASIC ET COMPLÉMENTAIRES À COMBINER LIBREMENT**
Éclairer votre terrasse et votre jardin avec un seul système : Par exemple, intégrer le kit Basic avec des luminaires encastrés dans la terrasse et l'étendre au parterre de fleurs avec le set de complément à piquets
- **PAS DE FASTIDIEUX ALLUMAGE ET EXTINCTION**
d'éteindre la lumière Extensible avec un capteur crépusculaire pour une commande simple par la lumière du jour
- **EXTENSIBLE DE MANIÈRE FLEXIBLE**
Grâce à différents sets de câbles, extensible jusqu'à puissance max. du transformateur et 15 mètres de longueur totale
- **ÉCLAIRAGE DE CHEMIN ET D'ACCENTUATION**
Éclairer les chemins et mettez en valeur les plantes individuelles en scène
- **CONNECTEUR EN T**
Adaptez le système à votre jardin en changeant simplement de direction à l'aide des connecteurs en T (plusieurs faisceaux de câbles possibles - 15 mètres max. chacun du transformateur au dernier luminaire).



BASIC-SET

Jedes BASIC-SET besteht aus:

- 3x Leuchte
- 3x Kabel 0,5m+0,5m
- 1x Zuleitung 1,5m
- 1x Trafo 12W

EN
Each BASIC-SET consists of:

- 3x light
- 3x cable 0,5m+0,5m
- 1x supply line 1.5m
- 1x transformer 12W

FR
Chaque BASIC-SET comprend:

- 3x lampe
- 3x câble 0,5m+0,5m
- 1x câble d'alimentation 1,5m
- 1x transformateur 12W

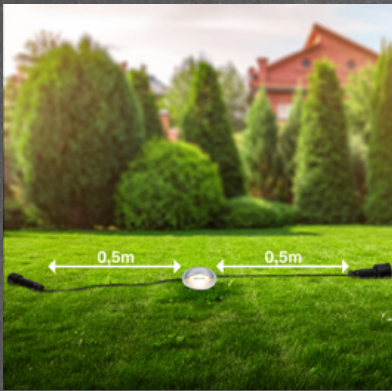

ERWEITERUNGS-SET*

Basic- und ERWEITERUNGS-SETs sind frei miteinander kombinierbar, solange die Gesamtleistung des Trafos nicht überschritten wird.

Jedes ERWEITERUNGS-SET besteht aus:

- 3x Leuchte
- 3x Kabel 0,5m+0,5m

EN
Each EXPANSION SET consists of:

- 3x light
- 3x cable 0,5m+0,5m

FR
Chaque SET D'EXTENSION comprend:

- 3x lampe
- 3x câble 0,5m+0,5m



*nur mit BASIC-SET verwendbar



ZUBEHÖR

DÄMMERUNGSSENSOR

CONNECT TO SHINE BY BRILONER

KABEL 3er Set



24W TRAFU FÜR GRÖßERE LICHTINSTALLATIONEN

T-VERBINDER 3er Set



PRODUKTWELT ENTDECKEN

LIGHTROOM



MONTAGE ERKLÄRUNG



GRENZENLOSE MÖGLICHKEITEN.

- Einfacher Einstieg durch Komplettssets
- Mühelose Installation dank Stecksystem
- Sicher durch 12V
- Große Produkt-Auswahl
- Flexibel & vielseitig
- Individuell erweiterbar
- Mit T-Verbindern und Dämmerungssensor kombinierbar



CONNECT
TO SHINE

1

BASIC-SET

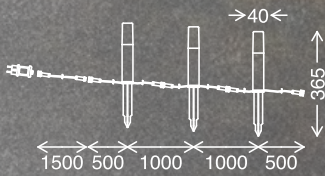

3925032

1

Edelstahl/stainless steel/
acier inoxydable

inkl. 3x LED/1 W 60lm
inkl. Transformator
3.000K
4002707455356





2 ERWEITERUNGS-SET

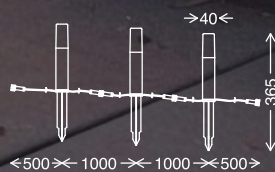

2

3926032

Edelstahl/stainless steel/
acier inoxydable

inkl. 3x LED/1 W 60 lm
3.000 K
4002707455363

IRIS

CONNECT TO SHINE



1 **BASIC-SET**

2 **ERWEITERUNGS-SET**

3927035

1

schwarz/black/noir

inkl. 3x LED/2W 135lm
inkl. Transformator
3.000K
4002707455424

3928035

2

schwarz/black/noir

inkl. LED/2W 135lm
3.000K
4002707455431



3 BASIC-SET



IP65

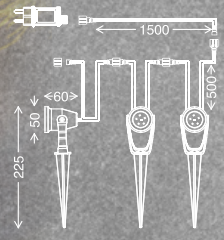

IP44

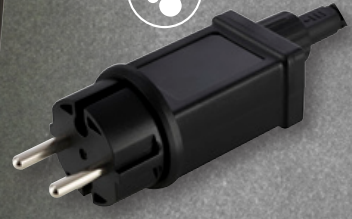

4 ERWEITERUNGS-SET

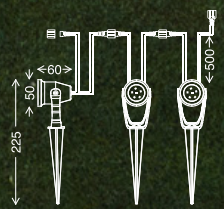

3 3918035

schwarz/black/noir
inkl. 3x LED/1 W 100 lm
inkl. Transformator
3.000 K
4002707455288

4 3919035

schwarz/black/noir
inkl. 3x LED/1 W 100 lm
3.000 K
4002707455295

1 BASIC-SET

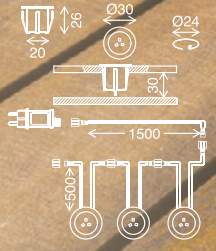

2 ERWEITERUNGS-SET

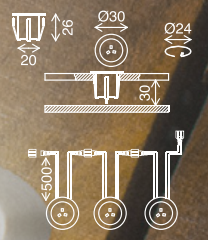

3912032

1

Edelstahl/stainless steel/
acier inoxydable

inkl. 3x LED/0,6 W 40 lm
inkl. Transformator
3.000 K
4002707455226

3913032

2

Edelstahl/stainless steel/
acier inoxydable

inkl. 3x LED/0,6 W 40 lm
3.000 K
4002707455233



CONNECT TO SHINE

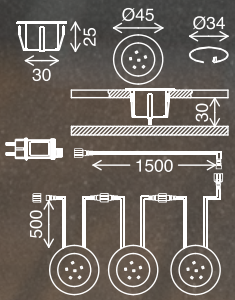

3 BASIC-SET

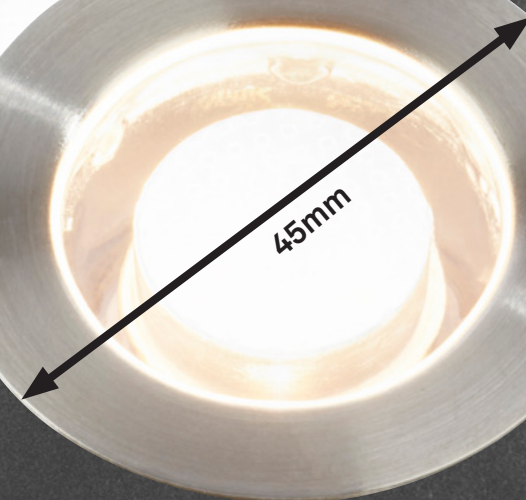

4 ERWEITERUNGS-SET

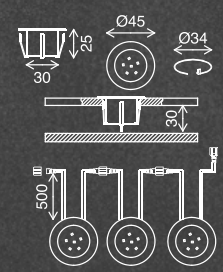

3 3914032
 Edelstahl/stainless steel/
 acier inoxydable
 inkl. 3x LED/1 W 100 lm
 inkl. Transformator
 3.000 K
 4002707455240

4 3915032
 Edelstahl/stainless steel/
 acier inoxydable
 inkl. 3x LED/1 W 100 lm
 3.000 K
 4002707455257

1 BASIC-SET



IP67

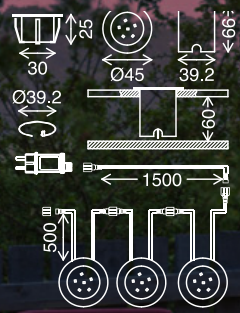

DURCH BODENEINBAUHÜLSE AUCH ZUR INSTALLATION IN BEETEN ODER RASENFLÄCHEN GEEIGNET.

EN Also suitable for installation in flower beds or lawns.

FR Grâce à la douille d'encastrement dans le sol, il est possible d'installer des ou de pelouse.

IP44

2 ERWEITERUNGS-SET

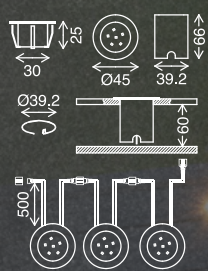

3916032

1

Edelstahl/stainless steel/
acier inoxydable

inkl. 3x LED/1 W 100lm
inkl. Transformator
3.000K
4002707455264

3917032

2

Edelstahl/stainless steel/
acier inoxydable

inkl. 3x LED/1 W 100lm
3.000K
4002707455271



CONNECT TO SHINE

3 BASIC-SET

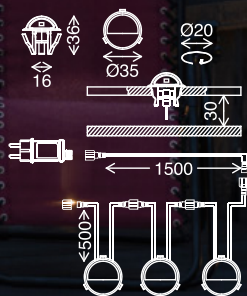

4 ERWEITERUNGS-SET

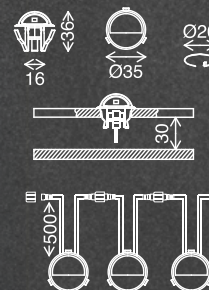

3 3922034

Edelstahl/stainless steel/
acier inoxydable

inkl. 3x LED/0,4W 10lm
inkl. Transformator
3.000K
4002707455301

4 3923034

Edelstahl/stainless steel/
acier inoxydable

inkl. 3x LED/0,4W 10lm
3.000K
4002707455332

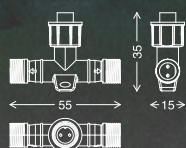

1
T-VERBINDER
 T-CONNECTOR | CONNECTEUR EN T



2
KABEL-SET – 3x 2M
 CABLE SET - 3X 2M | SET DE CÂBLES - 3X 2M

3910035

1

schwarz/black/noir

4002707455981

3920035

2

schwarz/black/noir

4002707455318

CONNECT
TO SHINE

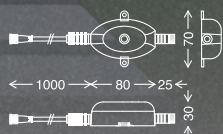

DÄMMERUNGSSENSOR
TWILIGHT SENSOR | DÉTECTEUR DE CRÉPUSCULE

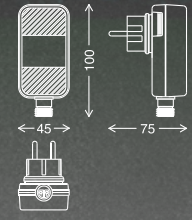

TRANSFORMATOR 24W
POWER SUPPLY 24W | ALIMENTATION ÉLECTRIQUE 24W

3 **3921015**

schwarz/black/noir

4002707455325

4 **3924015**

schwarz/black/noir

4002707455349

A woman with long, wavy brown hair, wearing a white tank top and a grey cardigan, is smiling and looking down at a wooden cutting board in a kitchen. She is standing in front of a brick wall and wooden cabinets. On the counter, there is a black pepper mill, a wooden pepper mill, a glass bowl of salad, and a small metal pot on a stovetop. The text '56 PIMP YOUR STRIPE' is overlaid on the image.

56 PIMP YOUR STRIPE



PIMP YOUR STRIPE



PIMP
YOUR
STRIPE

DAS LICHTSYSTEM FÜR IHR ZUHAUSE - PIMP YOUR STRIPE

„LED-Streifen können nur indirekte Beleuchtung. Der Streifen soll nicht sichtbar sein. Der Fokus liegt auf dem emittierten Licht“? Falsch! BRILONER ändert das jetzt. Mit PIMP YOUR STRIPE!

Mit PIMP YOUR STRIPE schaffen Sie eine außergewöhnliche Atmosphäre für Ihren Wohnraum. Heben Sie mit den Profilen die Ecken und Decken-Wand-Kanten Ihres Raumes hervor. Die Umrandung des Raumes lässt ihn größer wirken. Total modern: Verbauen Sie die Lichtleisten als Highlight in der Treppe. Diese Beleuchtung ist vor allem bei Holz sehr beliebt. Das dezente Licht verleiht der Treppe Eleganz und Sicherheit. Das LED-System ist IP 44 geschützt und eignet sich dadurch auch für den Außenbereich. Setzen Sie Ihre Terrasse oder Grillecke für lange Sommernächte perfekt in Szene.

EN

With PIMP YOUR STRIPE, you can create an extraordinary atmosphere for your living space. Use the profiles to emphasize the corners and ceiling/wall edges of your room. The border of the room makes it appear larger. Totally modern: Install the light strips as a highlight in the staircase. This lighting is particularly popular with wood. The discreet light lends the staircase elegance and safety. The LED system is IP 44 protected and is therefore also suitable for outdoor use. Set the perfect scene for your patio or barbecue area on long summer nights.

FR

Avec PIMP YOUR STRIPE, vous créez une atmosphère exceptionnelle pour votre espace de vie. Avec les profilés, vous faites ressortir les coins et les bords plafond-mur de votre pièce. En entourant votre pièce, vous la faites paraître plus grande. Totalement moderne : Intégrez les baguettes lumineuses comme point fort dans l'escalier. Cet éclairage est particulièrement apprécié pour le bois. La lumière discrète confère à l'escalier élégance et sécurité. Le système LED est protégé par IP 44 et convient donc également pour l'extérieur. Mettez parfaitement en scène votre terrasse ou votre coin barbecue pour les longues nuits d'été.



PIMP YOUR STRIPE

MIX & MATCH: Stellen Sie sich Ihr modulares Lichtleistensystem ganz einfach selbst zusammen!

MIX & MATCH: Put together your own modular batten luminaire system with ease!

MIX & MATCH: composez vous-même votre système modulaire de réglettes lumineuses en toute simplicité !

SCHIENE WÄHLEN

*Select a profile
Choisir un profilé*



BASIC-SET WÄHLEN

*Select basic set
Choisir le set de base*



ERWEITERUNGS-SET WÄHLEN (OPTIONAL)

Select extension set (optional)/Choisir le kit d'extension (en option)



STOSS- UND ECKVERBINDUNG

*Butt and corner joint/
Joints et angles*

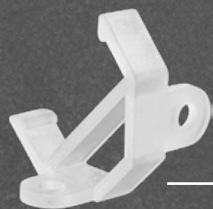

ADAPTER FÜR ECKMONTAGE

Adapter for corner mounting/Adaptateur pour montage en angle



45°

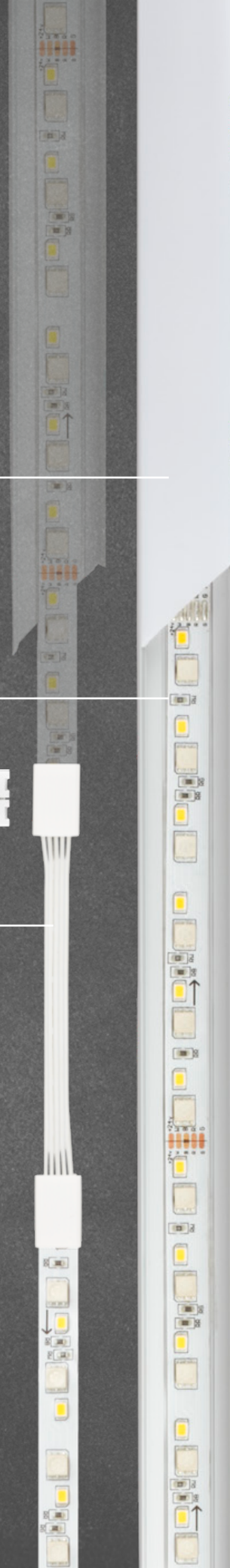

KINDERLEICHTE MONTAGE

EASY ASSEMBLY / UN MONTAGE FACILE

PIMP
YOUR
STRIPE

STRIPE EINKLEBEN (selbstklebend)
Stripe glue-in (self-adhesive)/Coller le ruban (autocollant)

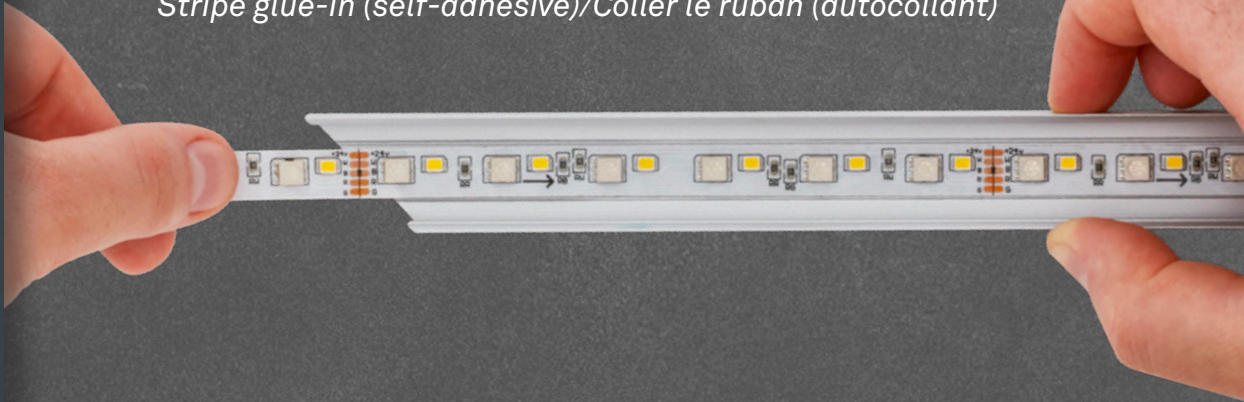

VERBINDEN
Connect/Relier

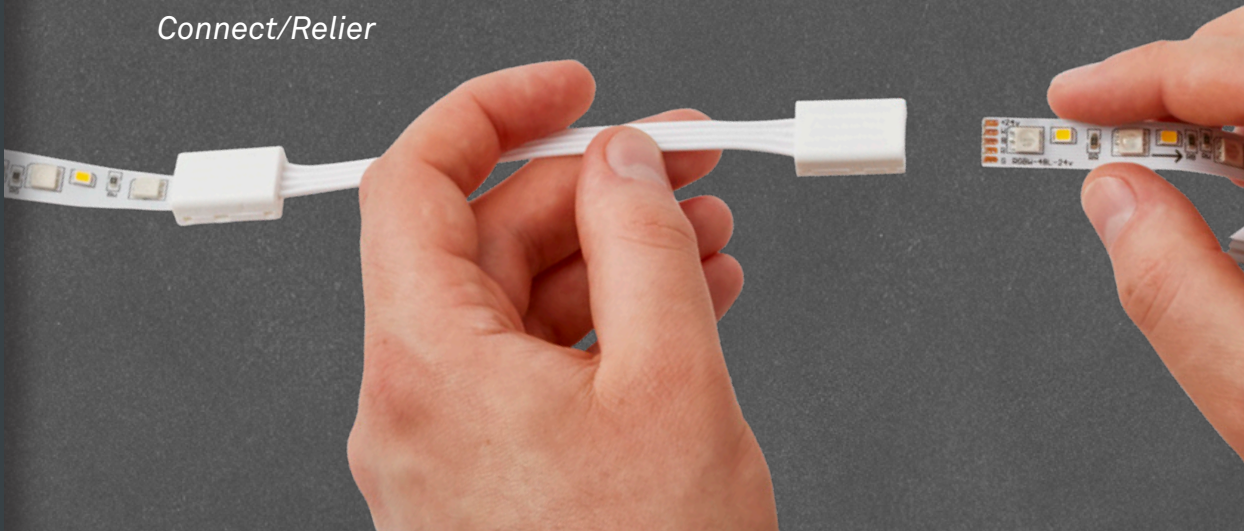

VERSCHLIESSEN
Close/Fermer





LIGHTROOM

INSPIRATION FÜR
INDIVIDUALISTEN

PIMP YOUR STRIPE



**JETZT IM VIDEO
DIE GANZE
PRODUKTVIELFALT
UND DIVERSE
MONTAGE-
MÖGLICHKEITEN
ENTDECKEN**

NOW IN THE VIDEO THE WHOLE
VARIETY OF PRODUCTS AND
DIVERSE ASSEMBLY POSSIBILITIES
DISCOVER

MAINTENANT EN VIDÉO
L'ENSEMBLE DIVERSITÉ DES
PRODUITS ET DIVERSE DE
MONTAGE POSSIBILITÉS
DÉCOUVRIR



SCHIENE

1

- INKL. MONTAGEMATERIAL FÜR KLEBEMONTAGE
- SELBSTKLEBEND
- INKL. 3 ENDKAPPEN
- AUCH ZUR SCHRAUBMONTAGE GEEIGNET
- MIT DIFFUSORABDECKUNG
- ERHÄLTliches ZUBEHÖR: 2160000 (siehe rechte Seite)



Kürzbar
Can be shortened
Peut être raccourci



1

2,0
m

2

2171015

1

schwarz/black/noir

4002707446699

2171019

2

aluminiumfarbig/
aluminium coloured/
couleur aluminium

4002707446682

2m



4

- NEIGUNGSWINKEL FÜR 45°-ECKMONTAGE
- 4ER-SET
- VERWENDBAR FÜR:
2171015 & 2171019 (siehe linke Seite)

3

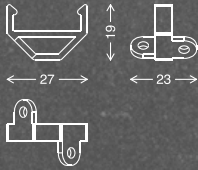

Einfache Eckmontage
Easy corner mounting
Montage en angle facile



3

2160000

transparent

4002707446934

BASIC-SET



2

- INKL. 3M ZULEITUNG
- SELBSTKLEBEND
- ERWEITERBAR AUF MAX. 10M
(Erweiterungs-Set siehe rechte Seite)

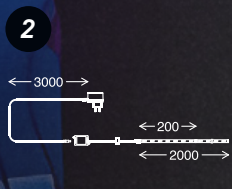
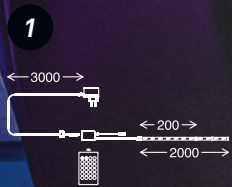

2153192

1

weiß/white/blanc

inkl. 96x LED 500 lm
3.000K
4002707446729



2154192

2

weiß/white/blanc

inkl. 96x LED 500 lm
3.000K
4002707446927

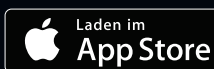

BASIC-SET

2

- INKL. 3M ZULEITUNG
- SELBSTKLEBEND
- ERWEITERBAR AUF MAX. 10M
(Erweiterungs-Set siehe rechte Seite)

1

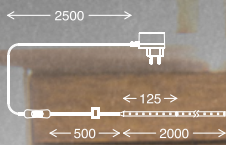

SCHIENE
+
BASIC-SET

2150112

1

weiß/white/blanc

inkl. 112x LED 1000 lm
3.000 - 6.500K
4002707446705



PIMP YOUR STRIPE

3

- INKL. VERBINDER
- SELBSTKLEBEND
- BETRIEB NUR IN VERBINDUNG MIT BASIC-SET (siehe linke Seite)

2

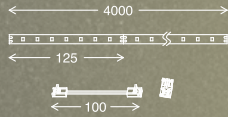

Verbinder inkl.

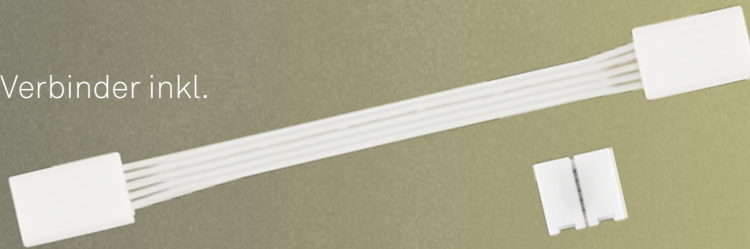

4m



2

2156224

weiß/white/blanc

inkl. 224x LED 2000 lm
3.000 K
4002707446705



2

- INKL. 3M ZULEITUNG
- SELBSTKLEBEND
- ERWEITERBAR AUF MAX. 10M
(Erweiterungs-Set siehe rechte Seite)

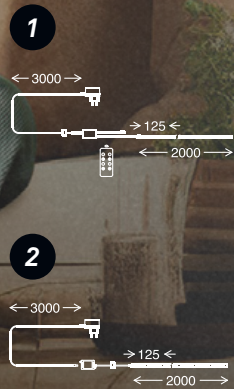

2151224

1

weiß/white/blanc

inkl. 224x LED 1000 lm
3.000 - 6.500K
4002707446712



2152224

2

weiß/white/blanc

inkl. 224x LED 1000 lm
3.000 - 6.500K
4002707446910



PIMP YOUR STRIPE

3

- INKL. VERBINDER
- SELBSTKLEBEND
- BETRIEB NUR IN VERBINDUNG MIT BASIC-SET (siehe linke Seite)

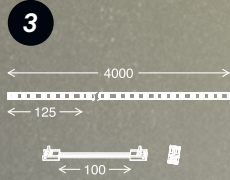

Verbinder inkl.

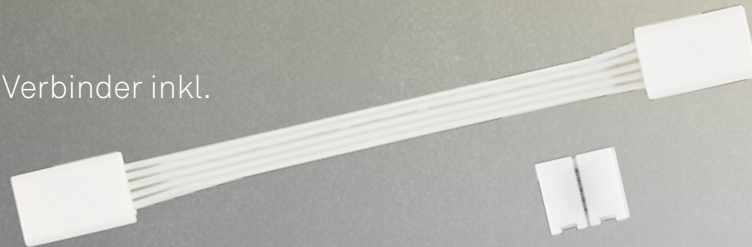

BASIC-SET
+
ERWEITERUNGS-SET

3

2157448

weiß/white/blanc

inkl. 448x LED 2000 lm
3.000 - 6.500K
4002707446743



4m

BASIC-SET

2

- INKL. 3M ZULEITUNG
- SELBSTKLEBEND
- ERWEITERBAR AUF MAX. 10M
(Erweiterungs-Set siehe rechte Seite)

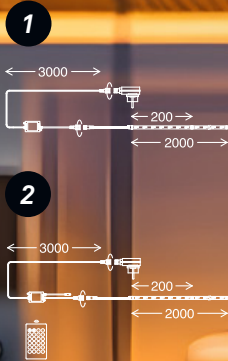

2166192

2

weiß/white/blanc

inkl. 96x LED 500 lm
3.000 K
4002707446958



2165192

1

weiß/white/blanc

inkl. 96x LED 500 lm
3.000 K
4002707446965



PIMP YOUR STRIPE

3

- INKL. VERBINDER
- SELBSTKLEBEND
- BETRIEB NUR IN VERBINDUNG MIT BASIC-SET (siehe linke Seite)

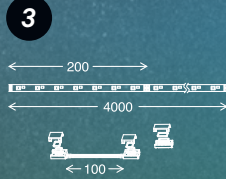

Verbinder inkl.

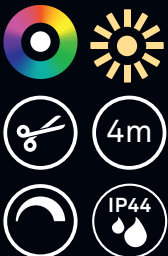
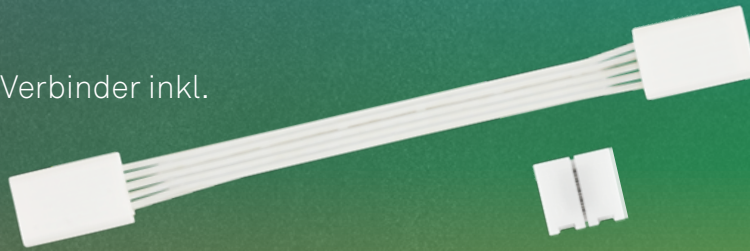

3

2167384

weiß/white/blanc

inkl. 192x LED 1000 lm
3.000 K
4002707446972



74 LED-EINBAULEUCHTEN

LED RECESSED LUMINAIRES
LUMINAIRES ENCASTRABLES LED





PLANEN SIE

LED GU10 | OHNE LEUCHTMITTEL

LED GU10 | 260 LUMEN

LED MODUL | 480 LUMEN

LED MODUL | 480 LUMEN

LED GU10 | OHNE LEUCHTMITTEL

LED GU10 | 460 LUMEN

LED MODUL | 480 LUMEN

LED MODUL | 480 LUMEN

LED GU10 | 460 LUMEN

LED GU10 | 460 LUMEN

LED MODUL | 300 LUMEN

LED MODUL | 350 LUMEN

LED GU10 | 460 LUMEN

ZEICHENERKLÄRUNG

- AN-AUS-SCHALTEN
- STUFENLOS DIMMBAR
- 3 STUFEN DIMMBAR
- LEUCHTMITTEL WECHSELBAR
- SCHEINBAR
- STARR
- EINBAU-MASS
- SCHUTZ-ART
- 3.000 K
- 4.000 K
- 3.000 K - 5.000 K
- RGB
- 1ER
- 3ER SET

BRILLOBER **EINBAUTIEFE 60MM**

BRILLOBER **EINBAUTIEFE 30MM**

1 2 3 4 5 6 7 8 9 10 11 12 13 14 15 16 17 18 19 20 21 22 23 24 25 26 27 28 29 30

HIER IHR LICHT



LED MODUL 470 LUMEN 1 2 3 4 5 6 7 8 9 10 11 12	LED MODUL 570 LUMEN 1 2 3 4 5 6 7 8 9 10 11 12	LED MODUL 450 LUMEN 1 2 3 4 5 6 7 8 9 10 11 12	LED MODUL 450 LUMEN 1 2 3 4 5 6 7 8 9 10 11 12
LED MODUL 400 LUMEN 13 14 15 16 17 18 19 20 21 22 23	LED MODUL 400 LUMEN 17 18 19 20 21 22 23	LED MODUL 350 LUMEN 700 LUMEN 11 12 13 14 15 16 17 18 19 20 21 22	LED FLAT 650 LUMEN 13 14 15 16 17 18 19 20 21 22 23
LED MODUL 150 LUMEN 280 LUMEN 24 25 26 27 28	LED MODUL 1000 LUMEN 29 30 31	LED FLAT 350 LUMEN 20 21 22 23 24 25 26 27 28	LED FLAT 450 LUMEN 18 19 20 21 22 23 24 25 26 27 28
LED MODUL 480 LUMEN 32 33 34	LED MODUL 350 LUMEN 35 36	LED FLAT 650 LUMEN 600 LUMEN 23 24 25 26 27 28	LED MODUL 600 LUMEN 29 30 31

EMBAUTIEPE 50MM **EMBAUTIEPE 50MM**

PLANEN SIE WIE IHR LICHT

6	1	2	3	4	5	6	7	8	9	10	11	12	1	2	3	4	5	6
12	13	14	15	16	17	18	19	7	8	9	10	11	12	13	14			
18	20	21	22	23	24	25	15	16	17	18	19							
24	26	27	28	29	30	31	20	21	22	23	24	25						
32	33	34	35	36	26	27	28	29	30	31								

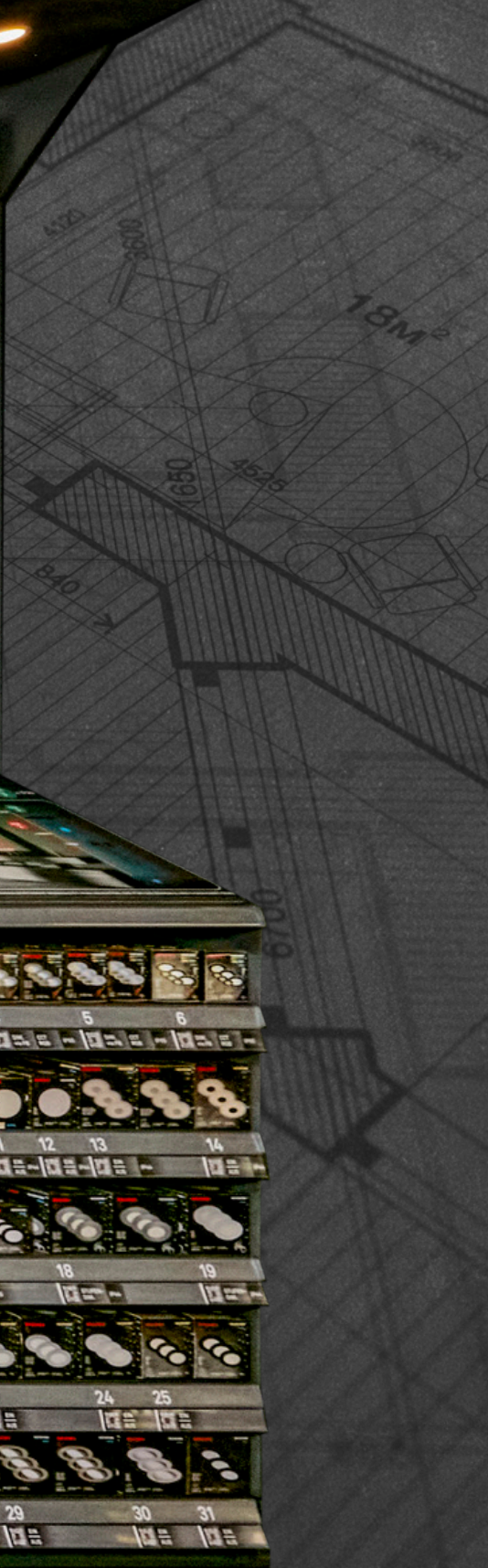

FastCalc

powered by DIALux

Hier geht's zu unserem
FastCalc Flyer:
Here you find our
FastCalc Flyer:
Cliquez ici pour voir notre
flyer **FastCalc:**



1 QR Code scannen



2 FastCalc öffnet sich



5 PDF generieren



3 Raumpersonalisierung

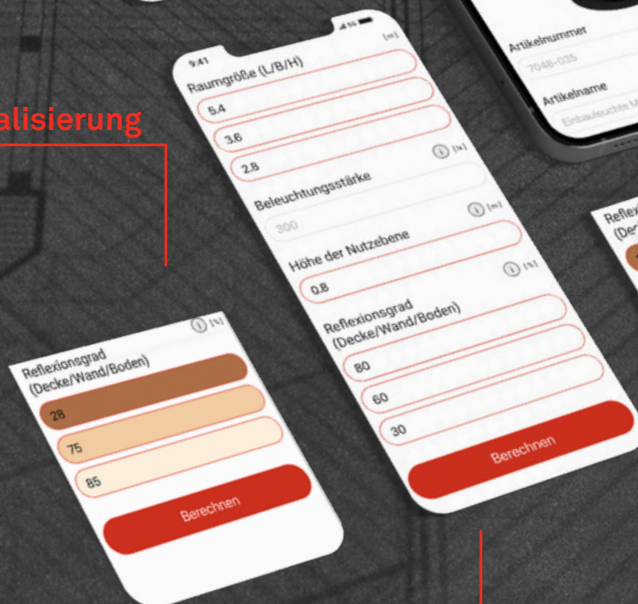

4 Berechnen



RE

DUCE EUSE CYCLE

BRILONER SETZT AUF NACHHALTIGKEIT!

Durch die Verwendung von Einbauringen aus 50% recyceltem Kunststoff tragen wir aktiv dazu bei, unseren CO₂-Ausstoß zu verringern.

Das ist umweltfreundlich und ressourcenschonend.

BRILONER FOCUSES ON SUSTAINABILITY!

By using installation rings made from 50% recycled plastic we actively contribute to reduce our CO₂ emissions. This is environmentally friendly and conserves resources.

BRILONER MISE SUR LA DURABILITÉ

Grâce à l'utilisation d'anneaux d'encastrement composés à 50% d'aluminium, la durabilité est assurée. de plastique recyclé nous contribuons activement à nos émissions de CO₂ de réduire les émissions de CO₂. C'est respectueux de l'environnement et préserve les ressources.



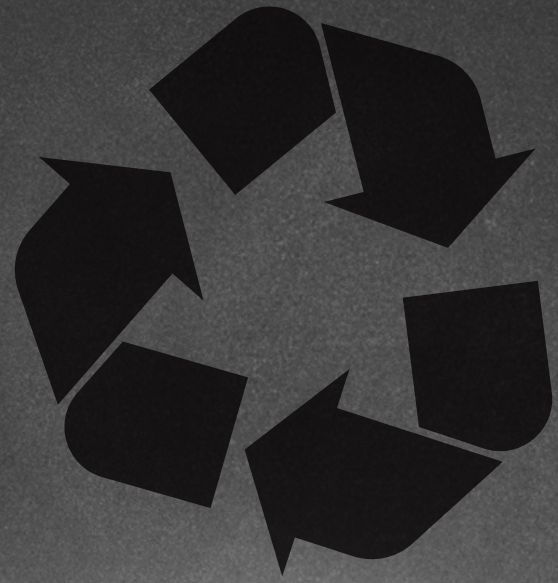

BRILONER
Light. Inspired by Life.

Reduce Reuse Recycle Rethink

DURCHDACHTES LICHT SCHONT DIE UMWELT!

50% RECYCLER KUNSTSTOFF

520 LUMEN
EINBAUTIEFE 25MM
EINBAU-D 6MM

ENERGIESPAREND
500 Lumen bei 5W

KLIMAFREUNDLICH
50% recycelbar

LANGLEBIG
25.000 h (bei 8h Leuchtzeit)

FARBREICH
Farbwiedergabeindex Ra 90

CLEVER
100° flächiges Licht
50° gerichtetes Licht

100° flächiges Licht

Schaltbar
50° gerichtetes Licht

1 3 7 9
2 4 8 10 12

ON OFF

Schaltbar
50° gerichtetes Licht

BRILONER LED-LEUCHTSTRAHLENER IN ALLEN ANWENDUNGSFÄHIG

BRILONER LED-LEUCHTSTRAHLENER

BRILONER LED-LEUCHTSTRAHLENER

BRILONER LED-LEUCHTSTRAHLENER

BRILONER LED-LEUCHTSTRAHLENER

BRILONER LED-LEUCHTSTRAHLENER

430
LUMEN

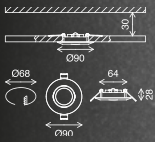

30MM EINBAUTIEFE | MOUNTING DEPTH | PROFONDEUR D'INSTALLATION

INKL. 3x LED Modul - 4,9 W, 430 lm



7587035 1

matt-schwarz
satin black
noir mat
2.500/3.000/4.000 K
4002707457251



7587036 2

weiß
white
blanc
2.500/3.000/4.000 K
4002707457268



7587032 3

matt-nickel
satin nickel
nickel mat
2.500/3.000/4.000 K
4002707457275



430
LUMEN

ON
OFF

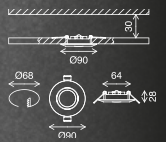

PROFONDEUR D'INSTALLATION | MOUNTING DEPTH | EINBAUTIEFE **30MM**

INKL. 3x LED Modul - 4,9 W, 430 lm

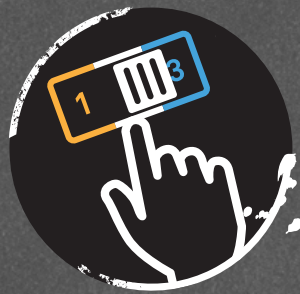

1 **7586035**

matt-schwarz
satin black
noir mat
2.500/3.000/4.000K
4002707457213



2 **7586036**

weiß
white
blanc
2.500/3.000/4.000K
4002707457237



3 **7586032**

matt-nickel
satin nickel
nickel mat
2.500/3.000/4.000K
4002707457244



50%
RECYCLAT

430
LUMEN

IP44

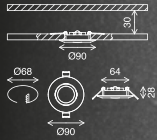

30MM EINBAUTIEFE | MOUNTING DEPTH | PROFONDEUR D'INSTALLATION

INKL. 3x LED Modul - 4,9 W, 430 lm



7589035 1

matt-schwarz
satin black
noir mat
2.500/3.000/4.000 K
4002707457312



7589036 2

weiß
white
blanc
2.500/3.000/4.000 K
4002707457329



7589032 3

matt-nickel
satin nickel
nickel mat
2.500/3.000/4.000 K
4002707457336



**430
LUMEN**

**ON
OFF**

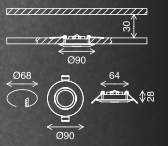
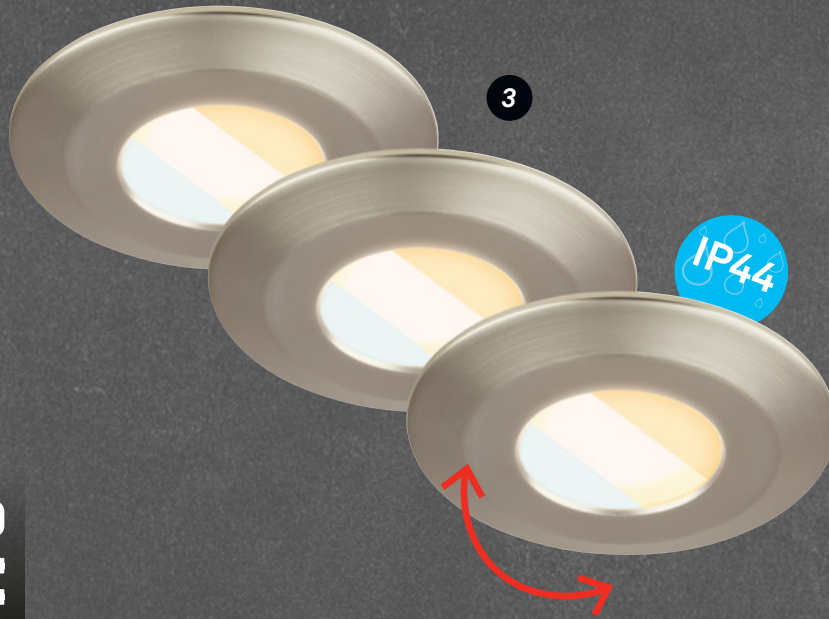

PROFONDEUR D'INSTALLATION | MOUNTING DEPTH | EINBAUTIEFE **30MM**

INKL. 3x LED Modul - 4,9 W, 430 lm

1 7588035

*matt-schwarz
satin black
noir mat
2.500/3.000/4.000K
4002707457282*



2 7588036

*weiß
white
blanc
2.500/3.000/4.000K
4002707457299*



3 7588032

*matt-nickel
satin nickel
nickel mat
2.500/3.000/4.000K
4002707457305*

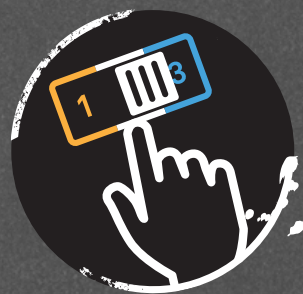

- **Geringe Einbautiefe 30mm**

Low installation depth (30mm)

Hauteur d'encastrement faible (30mm)

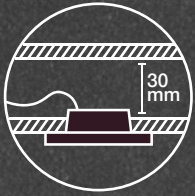

- **Montagefreundliche Anschlussbox ohne Trafo**

Easy an safe installation with the terminalbox

Pas de transfo nécessaire, connexion facile et sécurisée

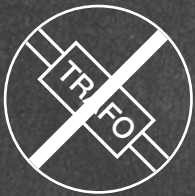

- **Hohe Lichtleistung von 480 Lumen pro Brennstelle**

High light output of 480 lumens per focal point

Rendement lumineux élevé de 480 lumens par lampe

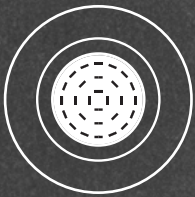

- **Mit anderen Produkten dieses Sortiments verbindbar**

Can be combined with other products in this range

Peut être combiné avec d'autres produits de cette gamme

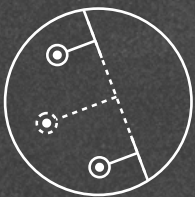

- **In den Standardfarben chrom-matt, weiß und matt-schwarz erhältlich**

Available in the standard colours satin chrome, white and satin black

Disponible dans les couleurs standard chrome mat, blanc et noir mat





KULANA JET

480
LUMEN



IP65

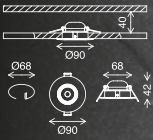

40MM EINBAUTIEFE | MOUNTING DEPTH | PROFONDEUR D'INSTALLATION

INKL. 3x LED Modul - 4,9 W, 480 lm



7602034 1

chrom-matt
chrome satin
chrome mat
3.000K
4002707444367



7602035 2

matt-schwarz
satin black
noir mat
3.000K
4002707444374



7602036 3

weiß
white
blanc
3.000K
4002707444350



IP65



480
LUMEN

ON
OFF



PROFONDEUR D'INSTALLATION | MOUNTING DEPTH | EINBAUTIEFE **30MM**

INKL. 3x LED-Modul - 5 W, 480 lm

1 **7044-034**

chrom-matt
chrome satin
chrome mat
3.000K
4002707418719



2 **7044-036**

weiß
white
blanc
3.000K
4002707418733



3 **7044-035**

matt-schwarz
satin black
noir mat
3.000K
4002707418726



480
LUMEN



IP44



30MM EINBAUTIEFE | MOUNTING DEPTH | PROFONDEUR D'INSTALLATION

INKL. 3x LED-Modul - 4,9 W, 480 lm



7047-034 1

chrom-matt
chrome satin
chrome mat
3.000 K
4002707378105



7047-036 2

weiß
white
blanc
3.000 K
4002707378112



7047-035 3

matt-schwarz
satin black
noir mat
3.000 K
4002707392576

580
LUMEN

ON
OFF

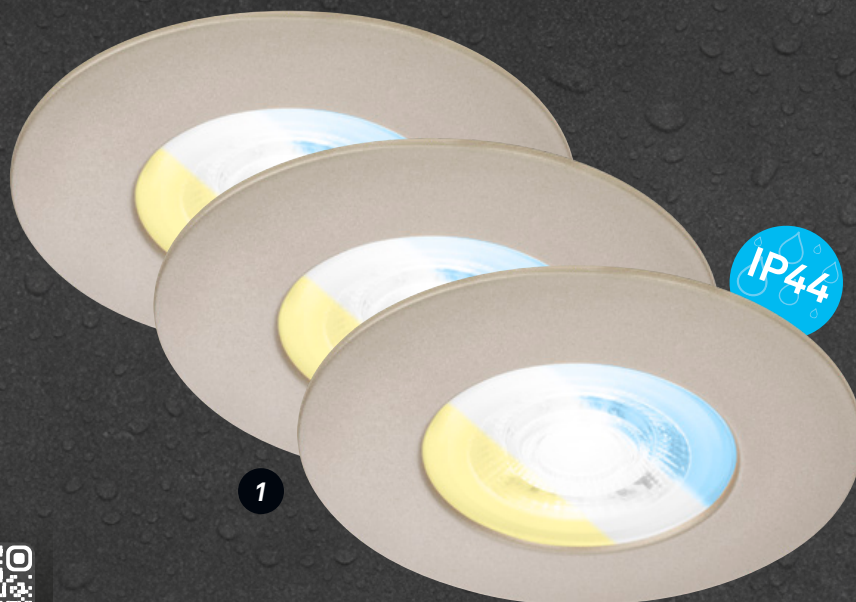

PROFONDEUR D'INSTALLATION | MOUNTING DEPTH | EINBAUTIEFE **40MM**

INKL. 3x LED Modul - 4,9 W, 580 lm

1 **7605032**

matt-nickel
satin nickel
nickel mat
2.700 K / 4.000 K / 6.500 K
4002707444800



2 **7605036**

weiß
white
blanc
2.700 K / 4.000 K / 6.500 K
4002707444794

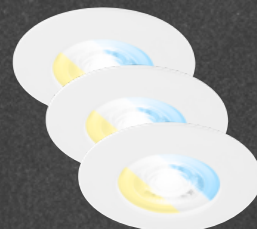

DE

- Farbtemperatur über Schalter am Gehäuse wählbar.

GB

- Colour temperature selectable via switch on housing.

FR

- Température de couleur sélectionnable par interrupteur sur le boîtier.

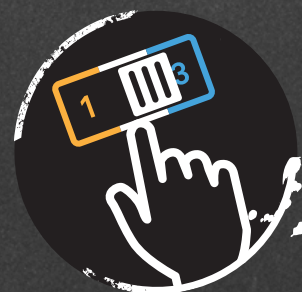

KULANA

480
LUMEN



30MM EINBAUTIEFE | MOUNTING DEPTH | PROFONDEUR D'INSTALLATION

INKL. 3x LED-Modul - 4,9 W, 480 lm



7036-034 1

chrom-matt
chrome satin
chrome mat
3.000 K
4002707423010



7036-036 2

weiß
white
blanc
3.000 K
4002707422990



7036-035 3

matt-schwarz
satin black
noir mat
3.000 K
4002707423003

480
LUMEN

ON
OFF



PROFONDEUR D'INSTALLATION | MOUNTING DEPTH | EINBAUTIEFE **30MM**

INKL. 1x LED PLATINE - 4,9W, 480 lm



1 **7046-014**

chrom-matt
chrome satin
chrome mat
3.000K
4002707378044



2 **7046-016**

weiß
white
blanc
3.000K
4002707378068

INKL. 3x LED PLATINE - 4,9W, 480 lm



3 **7046-034**

chrom-matt
chrome satin
chrome mat
3.000K
4002707378051



4 **7046-036**

weiß
white
blanc
3.000K
4002707378075



5 **7046-035**

matt-schwarz
satin black
noir mat
3.000K
4002707392569

KULANA MINI



340
LUMEN

ON
OFF

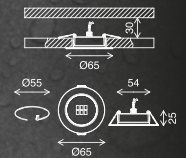

PROFONDEUR D'INSTALLATION | MOUNTING DEPTH | EINBAUTIEFE **30MM**

INKL. 3x LED Modul - 3,6W, 340 lm

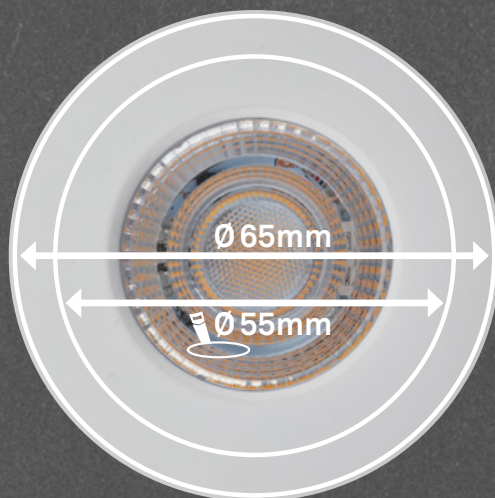

*Originalgröße
original Size
format original

1 **7606034**

chrom-matt
chrome satin
chrome mat
3.000K
4002707444831



2 **7606035**

schwarz
black
noir
3.000K
4002707444817



3 **7606036**

weiß
white
blanc
3.000K
4002707444824



KULANA

480
LUMEN

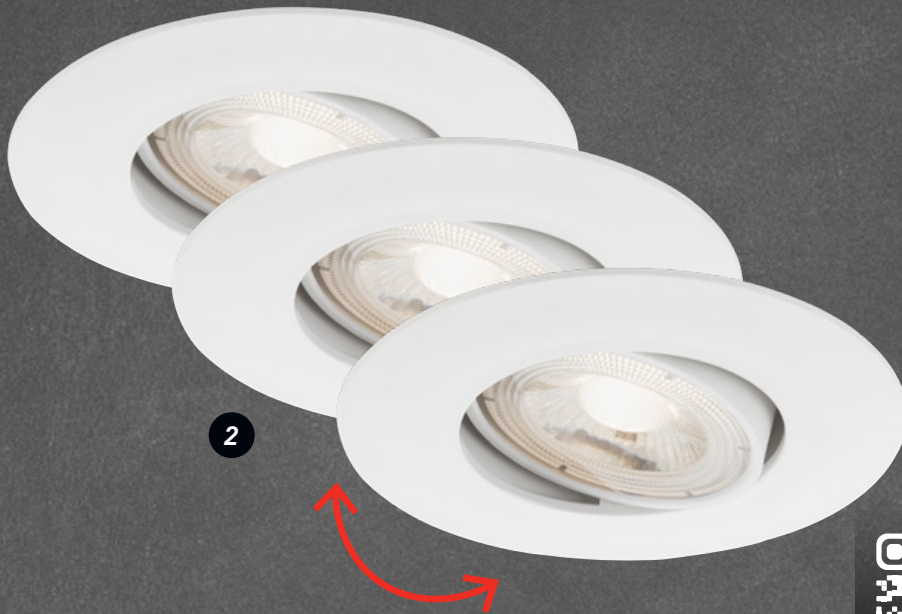

30MM EINBAUTIEFE | MOUNTING DEPTH | PROFONDEUR D'INSTALLATION

INKL. 3x LED-Modul - 4,9 W, 480 lm



7048-034 1

chrom-matt
chrome satin
chrome mat
3.000 K
4002707378143



7048-036 2

weiß
white
blanc
3.000 K
4002707378150



7048-035 3

matt-schwarz
satin black
noir mat
3.000 K
4002707392583

480
LUMEN

ON
OFF



PROFONDEUR D'INSTALLATION | MOUNTING DEPTH | EINBAUTIEFE **30MM**

INKL. 3x LED-Modul - 4,9W, 480 lm

4 **7146-034**

chrom-matt
chrome satin
chrome mat
3.000K
4002707369165



5 **7146-036**

weiß
white
blanc
3.000K
4002707369370



6 **7146-035**

matt-schwarz
satin black
noir mat
3.000K
4002707392590



VERRE

650
LUMEN

ON
OFF

IP44

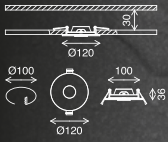

30MM EINBAUTIEFE | MOUNTING DEPTH | PROFONDEUR D'INSTALLATION

INKL. 3x LED Modul - 6W, 650 lm



7043-039 1

aluminiumfarbig
aluminium coloured
couleur aluminium
3.000 K
4002707422983



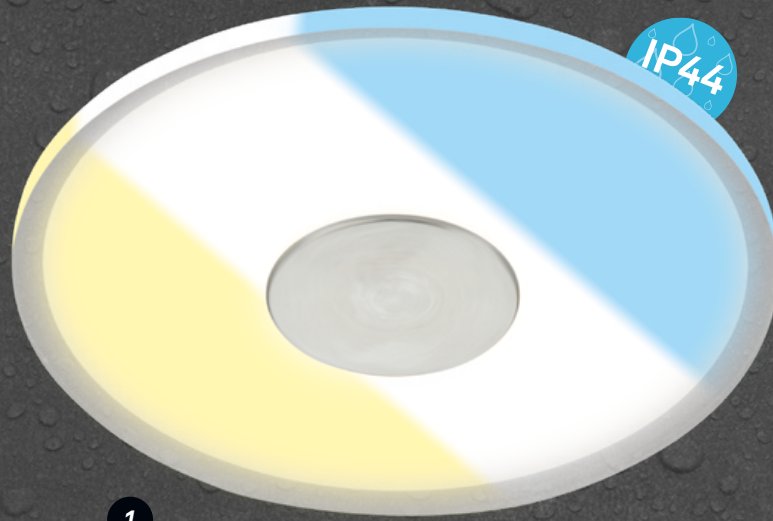

1

640
LUMEN

1200
LUMEN

1400
LUMEN

ON
OFF

PROFONDEUR D'INSTALLATION | MOUNTING DEPTH | EINBAUTIEFE **30MM**

INKL. 1x LED
6W, 640 lm

INKL. 1x LED
12W, 1200 lm

INKL. 1x LED
14W, 1400 lm



1 **7480019**

2 **7481019**

3 **7482019**

aluminiumfarbig
aluminium coloured
couleur aluminium
3.000 K / 4.000 K / 6.500 K
4002707444893

aluminiumfarbig
aluminium coloured
couleur aluminium
3.000 K / 4.000 K / 6.500 K
4002707444909

aluminiumfarbig
aluminium coloured
couleur aluminium
3.000 K / 4.000 K / 6.500 K
4002707444916

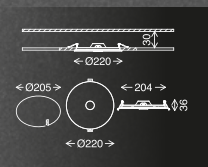
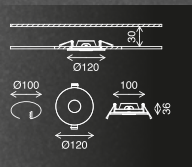

- Ein rundes Konzept
A complete package
Un concept qui fonctionne

- Gezielte Informationen
Targeted information
Information ciblée

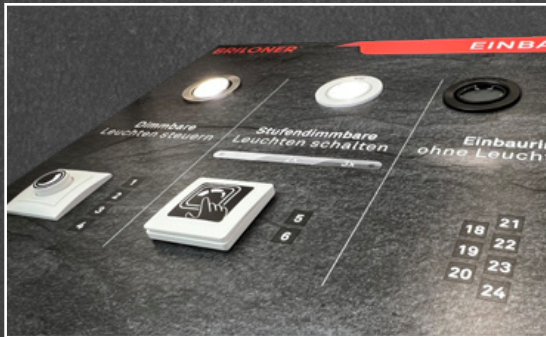

- **Nur 6cm Einbautiefe durch Anschlussbox**
Only 6cm installation depth due to connection box
Seulement 6cm de profondeur de montage grâce à un boîtier de connexion
- **Leuchtmittel wechselbar**
Exchangeable bulb
Ampoule interchangeable
- **An/Aus, dimmbar oder stufendimmbare**
On/off, infinitely dimmable or dimmable in steps
Marche/arrêt, variable ou réglable en continu
- **Mit IP Schutzart erhältlich**
Available with IP protection class
Disponible avec classe de protection IP

matt-nickel
satin nickel
nickel mat

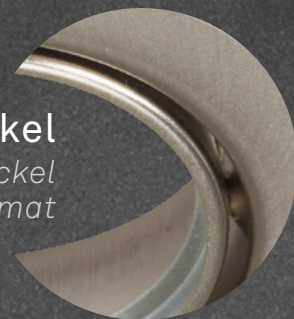

aluminiumfarbig
aluminium coloured
couleur aluminium

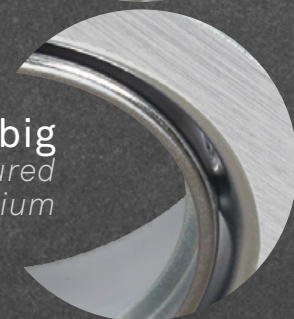

chrom
chrome
chrome



messing
brass
laiton



weiß
white
noir



schwarz
black
noir

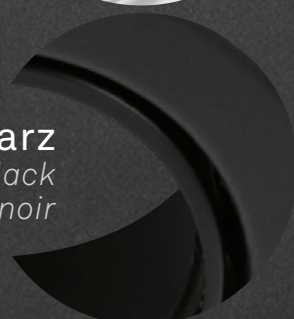

OHNE
LM



2

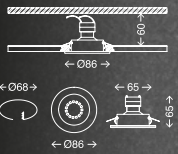

60MM EINBAUTIEFE | MOUNTING DEPTH | PROFONDEUR D'INSTALLATION

EXKL. LEUCHTMITTEL; INKL. GU10 FASSUNG

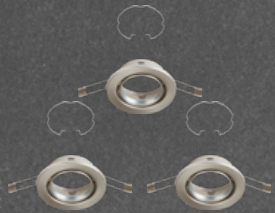

7110-032 1

*matt-nickel
satin nickel
nickel mat*

4002707363750

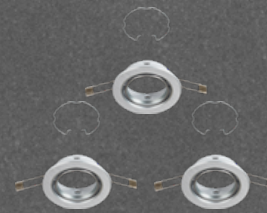

7110-039 5

*aluminiumfarbig
aluminium coloured
couleur aluminium*

4002707364115

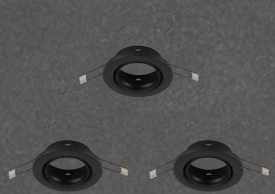

7110-035 2

*schwarz
black
noir*

4002707409595

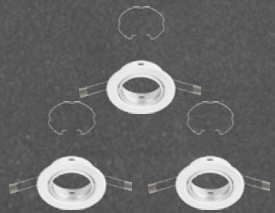

7110-036 3

*weiß
white
blanc*

4002707363767

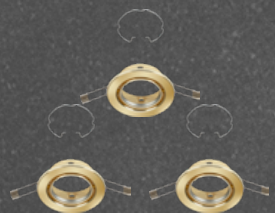

7110-037 4

*messing
brass
laiton*

4002707363774

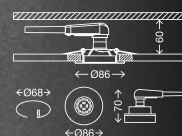
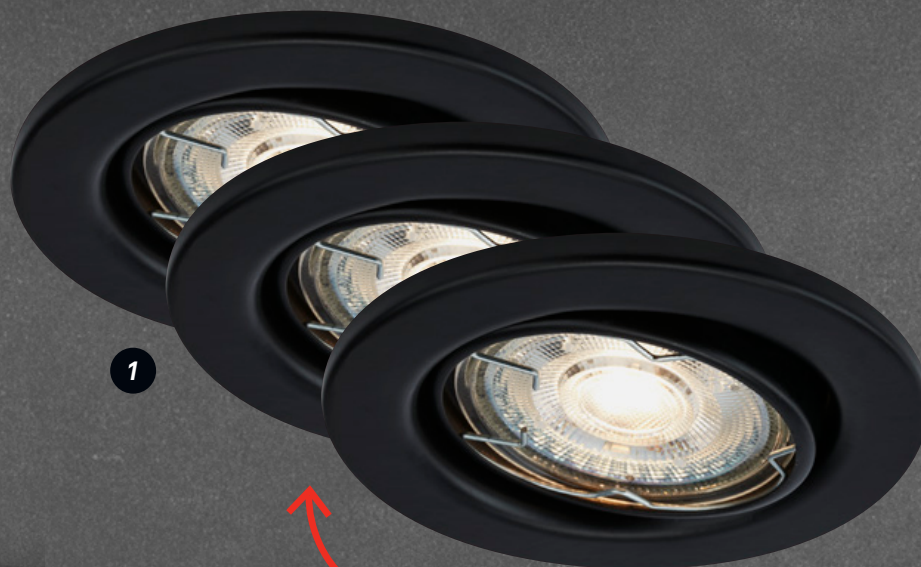
460
LUMENON
OFF

PROFONDEUR D'INSTALLATION | MOUNTING DEPTH | EINBAUTIEFE **60MM**

INKL. 3x LED/GU10 - 5W, 460 lm

1 **7147-035**

*matt-schwarz
satin black
noir mat
3.000K
4002707402459*



2 **7147-036**

*weiß
white
blanc
3.000K
4002707370314*



3 **7147-038**

*chrom
chrome
chrome
3.000K
4002707370338*



4 **7147-039**

*aluminiumfarbig
aluminium coloured
couleur aluminium
3.000K
4002707370352*

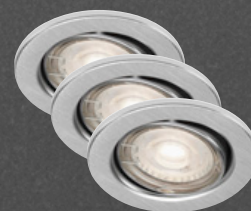

260
LUMEN

ON
OFF

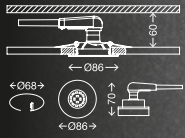

60MM EINBAUTIEFE | PROFONDEUR D'INSTALLATION | MOUNTING DEPTH

INKL. 3x LED/GU10 - 3 W, 260 lm



7225-038 1

chrom
chrome
chrome
3.000 K
4002707260561



7225-039 2

aluminiumfarbig
aluminium coloured
couleur aluminium
3.000 K
4002707310747



400
LUMEN

ON
OFF



IP65

2

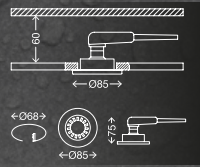

PROFONDEUR D'INSTALLATION | MOUNTING DEPTH | EINBAUTIEFE **60MM**

INKL. 3x LED/GU10 - 4,7W, 400 lm

1 **7181-032**

matt-nickel
satin nickel
nickel mat
3.000K
4002707353911

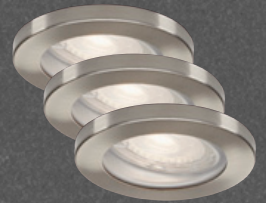

2 **7181-036**

weiß
white
blanc
3.000K
4002707353928



3 **7181-035**

matt-schwarz
satin black
noir mat
3.000K
4002707414056





- **Energieersparnis bis zu 80% gegenüber Glühlampenbeleuchtung**

Approx. 80% cost savings compared to incandescent lighting

Env. 80% de consommation électrique en moins par rapport à une ampoule à incandescence classique



- **Geringe Einbautiefe 30mm**

Low installation depth (30mm)

Hauteur d'encastrement faible (30mm)

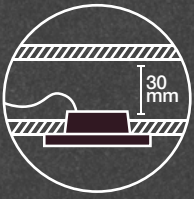

- **Montagefreundliche Anschlussbox ohne Trafo**

Easy an safe installation with the terminalbox

Pas de transfo nécessaire, connexion facile et sécurisée



- **Mit anderen Produkten dieses Sortiments verbindbar**

Can be combined with other products in this range

Peut être combiné avec d'autres produits de cette gamme

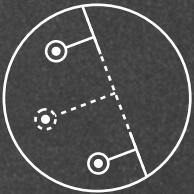

FUNGO COLOR

450
LUMEN

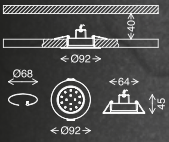
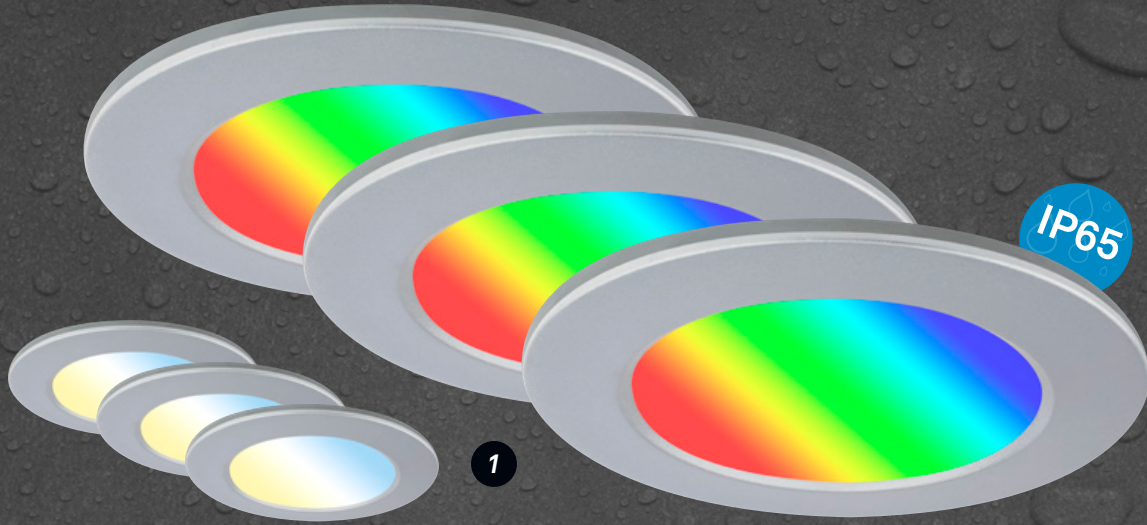

inkl.



40MM EINBAUTIEFE | MOUNTING DEPTH | PROFONDEUR D'INSTALLATION

INKL. 3x LED Modul - 4,8 W, 450 lm

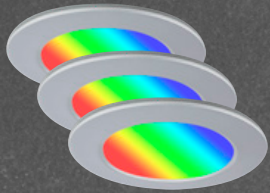

7035-034 1

chrom-matt
chrome satin
chrome mat
3.000 K - 6.500 K + RGB
4002707422945

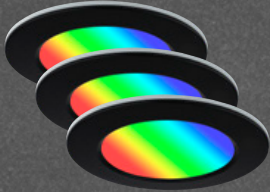

7035-035 2

schwarz
black
noir
3.000 K - 6.500 K + RGB
4002707422921

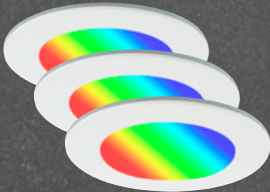

7035-036 3

weiß
white
blanc
3.000 K - 6.500 K + RGB
4002707422938



450
LUMEN

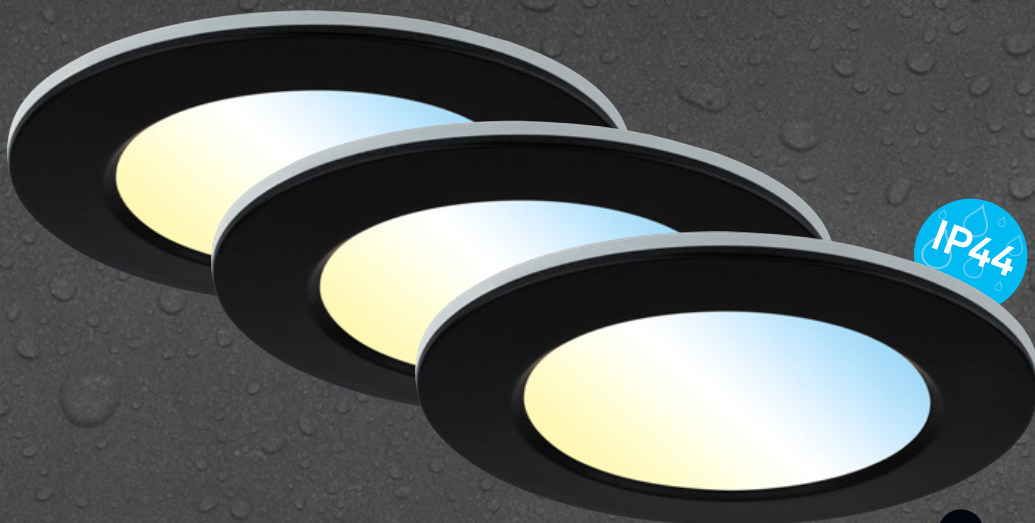

2



inkl.



PROFONDEUR D'INSTALLATION | MOUNTING DEPTH | EINBAUTIEFE **40MM**

INKL. 1x LED Modul - 4,8 W, 450 lm

1 **7034-034**

chrom-matt
chrome satin
chrome mat
3.000 K - 6.500 K
4002707422907

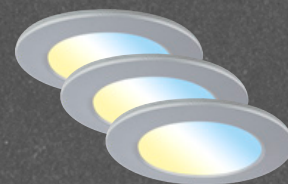

2 **7034-035**

schwarz
black
noir
3.000 K - 6.500 K
4002707422891



3 **7034-036**

weiß
white
blanc
3.000 K - 6.500 K
4002707422884



FLAT JET

480
LUMEN



IP65

1

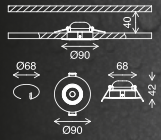

40MM EINBAUTIEFE | PROFONDEUR D'INSTALLATION | MOUNTING DEPTH

INKL. 3x LED Modul - 4,9 W, 480 lm

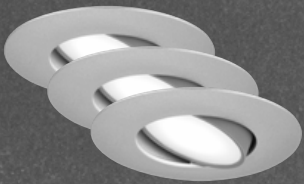

7597034 1

chrom-matt
chrome satin
chrome mat
4.000 K
4002707445081



7597035 2

schwarz
black
noir
4.000 K
4002707445104



7597036 3

weiß
white
blanc
4.000 K
4002707445111

350
LUMEN

ON
OFF

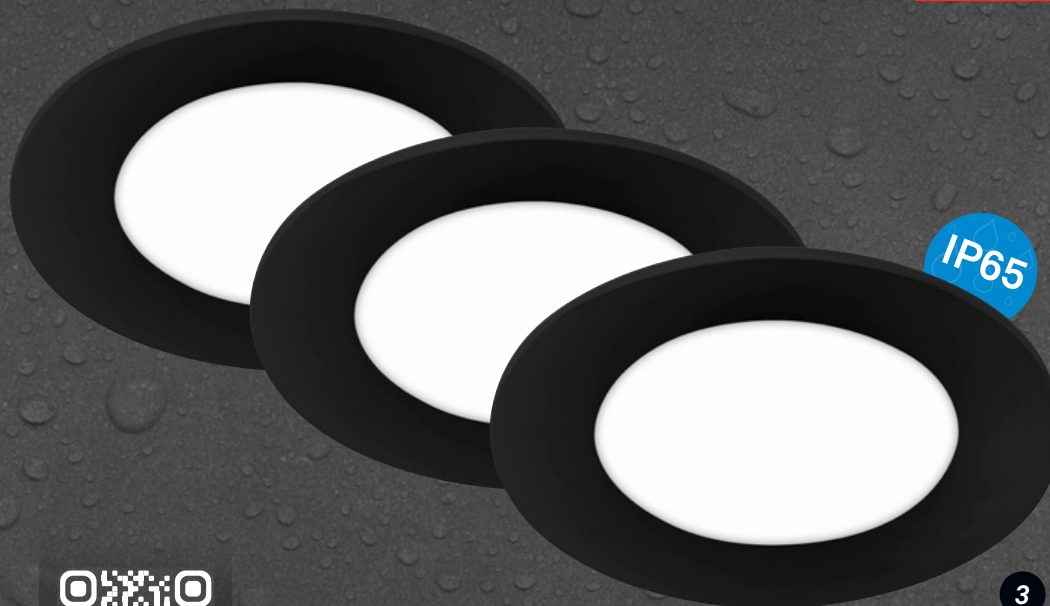

3



PROFONDEUR D'INSTALLATION | MOUNTING DEPTH | EINBAUTIEFE **30MM**

INKL. 3x LED Modul - 3 W, 350 lm

1 **7057-436**

weiß
white
blanc
4.000 K
4002707411345



2 **7057-434**

chrom-matt
chrome satin
chrome mat
4.000 K
4002707422860

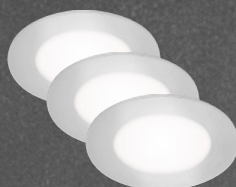

3 **7057-435**

schwarz
black
noir
4.000 K
4002707422853

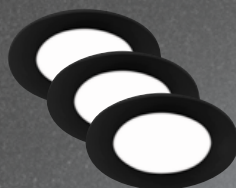





800
LUMEN

ON
OFF



1



PROFONDEUR D'INSTALLATION | MOUNTING DEPTH | EINBAUTIEFE **30MM**

INKL. 3x LED-Platine - 7 W, 800 lm

3 **7284-032**

*matt-nickel
satin nickel
nickel mat
4.000K
4002707324027*

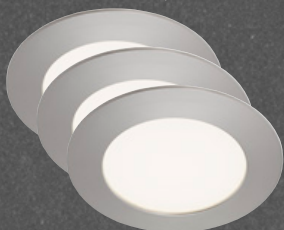

4 **7284-036**

*weiß
white
blanc
4.000K
4002707319771*



INKL. 1x LED-Platine - 7 W, 800 lm

1 **7284-012**

*matt-nickel
satin nickel
nickel mat
4.000K
4002707324010*



2 **7284-016**

*weiß
white
blanc
4.000K
4002707319610*



FLAT SELECT

580
LUMEN

EIN
AUS

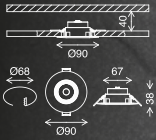
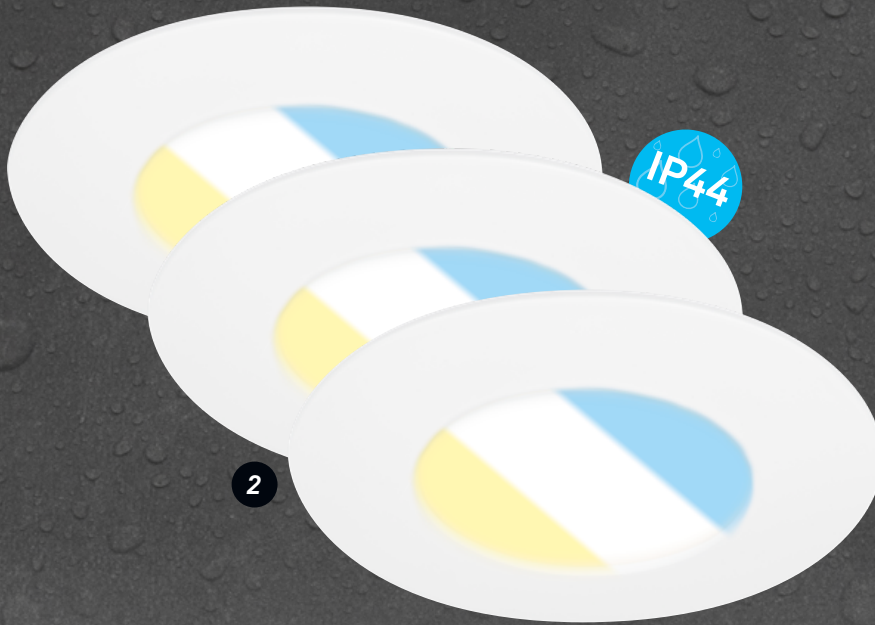

40MM EINBAUTIEFE | MOUNTING DEPTH | PROFONDEUR D'INSTALLATION

INKL. 3x LED Modul - 4,9 W, 580 lm

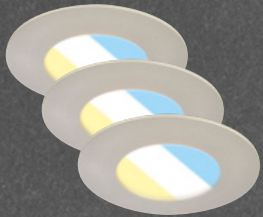

7598032 1

*matt-nickel
satin nickel
nickel mat
2.700 K / 4.000 K / 6.500 K
4002707445067*



7598036 2

*weiß
white
blanc
2.700 K / 4.000 K / 6.500 K
4002707445074*



DE

- Farbtemperatur über Schalter am Gehäuse wählbar.

GB

- Colour temperature selectable via switch on housing.

FR

- Température de couleur sélectionnable par interrupteur sur le boîtier.

600
LUMEN

ON
OFF



3



PROFONDEUR D'INSTALLATION | MOUNTING DEPTH | EINBAUTIEFE **30MM**

INKL. 3x LED-Platine - 6 W, 600 lm

1 **7115-432**

matt-nickel
satin nickel
nickel mat
4.000 K
4002707363194



2 **7115-436**

weiß
white
blanc
4.000 K
4002707363187



3 **7115-435**

matt-schwarz
satin black
noir mat
4.000 K
4002707402527



THIN

650
LUMEN

ON
OFF

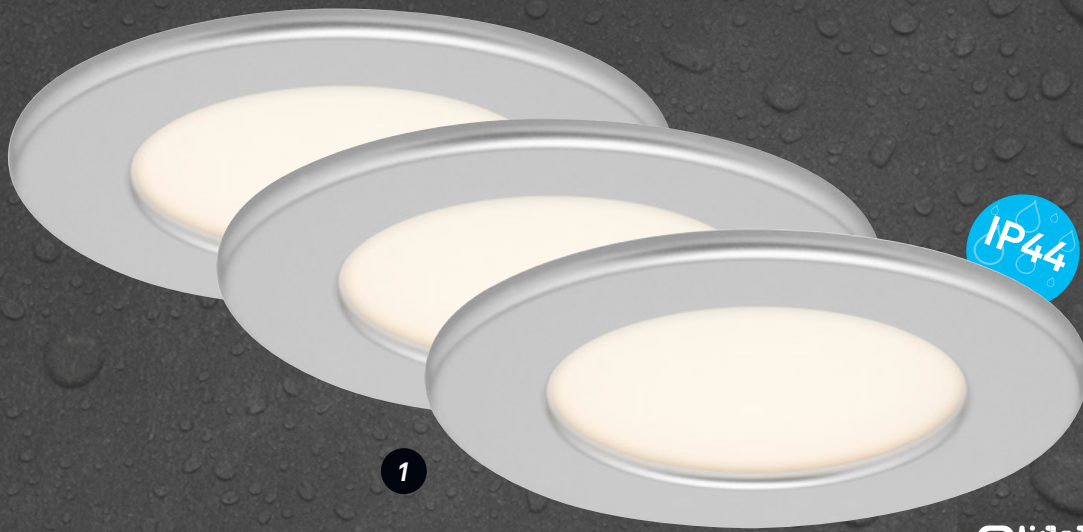

1

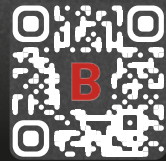

30MM EINBAUTIEFE | MOUNTING DEPTH | PROFONDEUR D'INSTALLATION

INKL. 3x LED-Modul - 6W, 650 lm



7053-034 1

chrom-matt
chrome satin
chrome mat
3.000K
4002707384441



7053-036 2

weiß
white
blanc
3.000K
4002707384427



7053-035 3

matt-schwarz
satin black
noir mat
3.000K
4002707402503

THIN

IP44

600
LUMEN



2



PROFONDEUR D'INSTALLATION | MOUNTING DEPTH | EINBAUTIEFE **30MM**

INKL. 1x LED Modul - 6 W, 600 lm

1 **7049014**

chrom-matt
chrome satin
chrome mat
4.000K
4002707384397



2 **7049015**

schwarz
black
noir
4.000K
4002707444848



3 **7049016**

weiß
white
blanc
4.000K
4002707378167



FLAT IN

600
LUMEN

ON
OFF



2

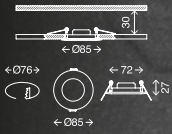

30MM EINBAUTIEFE | MOUNTING DEPTH | PROFONDEUR D'INSTALLATION

INKL. 1x LED-Platine - 5,5 W, 600 lm



7282-012 1

*matt-nickel
satin nickel
nickel mat
4.000 K
4002707323990*



7282-016 2

*weiß
white
blanc
4.000 K
4002707319573*

INKL. 3x LED-Platine - 5,5 W, 600 lm



7282-032 3

*matt-nickel
satin nickel
nickel mat
4.000 K
4002707324003*



7282-036 4

*weiß
white
blanc
4.000 K
4002707319597*

450
LUMEN

ON
OFF



3

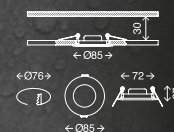

PROFONDEUR D'INSTALLATION | MOUNTING DEPTH | EINBAUTIEFE **30MM**

INKL. 3x LED-Platine - 5 W, 450 lm

1 **7113-432**

matt-nickel
satin nickel
nickel mat
4.000K
4002707363125



2 **7113-436**

weiß
white
blanc
4.000K
4002707363132



3 **7113-435**

matt-schwarz
satin black
noir mat
4.000K
4002707402480



FLAT IN

350
LUMEN

ON
OFF



30MM EINBAUTIEFE | PROFONDEUR D'INSTALLATION | MOUNTING DEPTH

INKL. 3x LED-Platine - 3 W, 350 lm



7125-436 1

weiß
white
blanc
4.000K
4002707363293

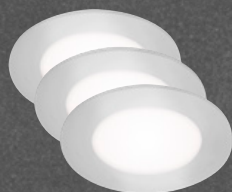

7125-434 2

chrom-matt
chrome satin
chrome mat
4.000K
4002707422389

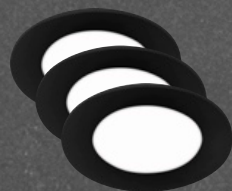

7125-435 3

schwarz
black
noir
4.000K
4002707422396

INKL. 1x LED-Platine - 3 W, 350 lm



7125-416 4

weiß
white
blanc
4.000K
4002707363286

600
LUMEN

ON
OFF



1



PROFONDEUR D'INSTALLATION | MOUNTING DEPTH | EINBAUTIEFE **30MM**

INKL. 3x LED-Platine - 7W, 600 lm

3 **7114-432**

*matt-nickel
satin nickel
nickel mat
4.000 K
4002707363231*

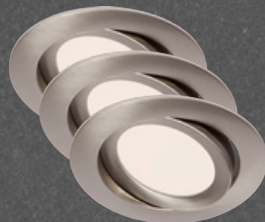

4 **7114-436**

*weiß
white
blanc
4.000 K
4002707363224*

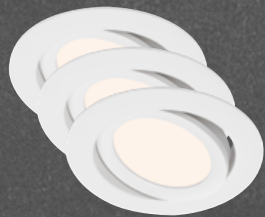

5 **7114-435**

*matt-schwarz
satin black
noir mat
4.000 K
4002707402541*



INKL. 1x LED-Platine - 7W, 600 lm

1 **7114-412**

*matt-nickel
satin nickel
nickel mat
4.000 K
4002707363200*



2 **7114-416**

*weiß
white
blanc
4.000 K
4002707363217*





ON
OFF



1

PROFONDEUR D'INSTALLATION | MOUNTING DEPTH | EINBAUTIEFE **30MM**

INKL. 3x LED-Platine - 3 W, 330 lm

INKL. 3x LED-Platine - 6 W, 660 lm

1

7992036

weiß
white
blanc
4.000 K
4002707459002

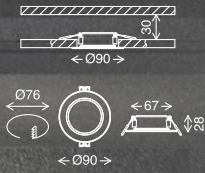

2

7993036

weiß
white
blanc
4.000 K
4002707459019

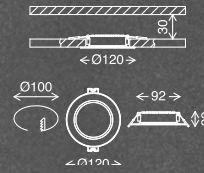
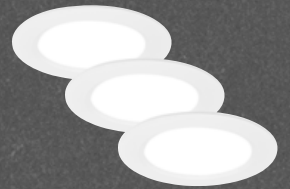

450
LUMEN



1



EIN-/AUFBAULEUCHTE | LUMINAIRES À MONTER/À DÉMONTER | IN/OUT LIGHT

INKL. 1x LED-Platine - 5 W, 450 lm

INKL. 1x LED-Platine - 5 W, 450 lm



7991015 1

schwarz
black
noir
3.000 K
4002707458944



7990015 4

schwarz
black
noir
3.000 K
4002707458975



7991016 2

weiß
white
blanc
3.000 K
4002707458951



7990016 5

weiß
white
blanc
3.000 K
4002707458982



7991014 3

chrom-matt
chrome satin
chrome mat
3.000 K
4002707458968



7990014 6

chrom-matt
chrome satin
chrome mat
3.000 K
4002707458999

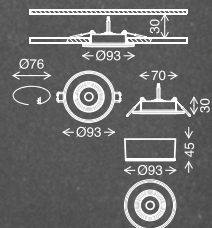
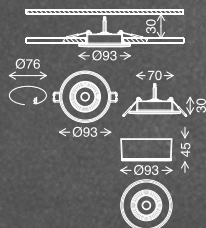



2 MONTAGEMÖGLICHKEITEN

2 MOUNTING OPTIONS

2 POSSIBILITÉS DE MONTAGE

460
LUMEN

ON
OFF

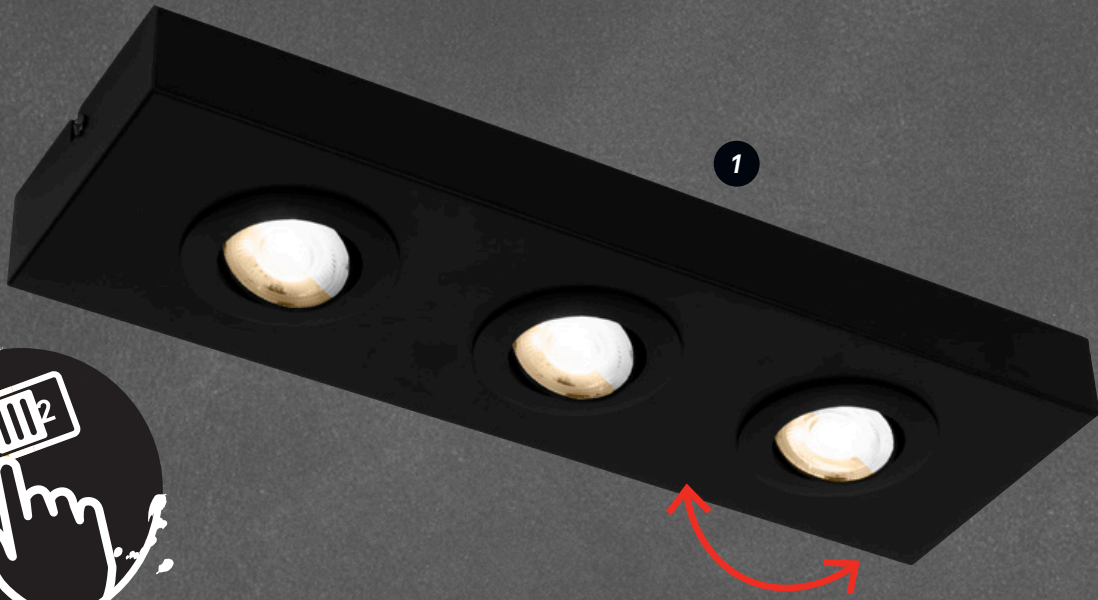

AUFBAULEUCHE | LUMINAIRE APPARENT | SURFACE-MOUNTED LIGHT

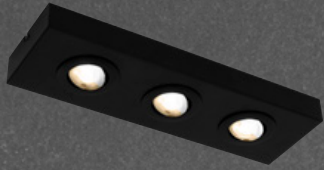

3996035 1

schwarz/black/noir

inkl. 3x LED 4,2W 460lm
2.700K / 4.000K
4002707445340

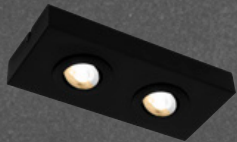

3996025 2

schwarz/black/noir

inkl. 2x LED 4,2W 460lm
2.700K / 4.000K
4002707445326

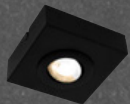

3996015 3

schwarz/black/noir

inkl. 1x LED 4,2W 460lm
2.700K / 4.000K
4002707445319



460
LUMEN

ON
OFF

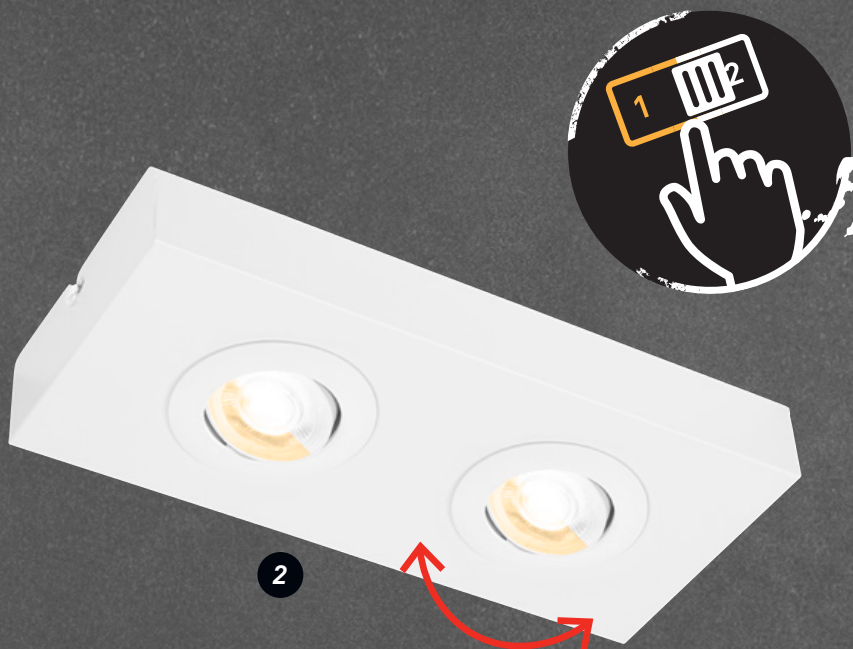

AUFBAULEUCHE | LUMINAIRE APPARENT | SURFACE-MOUNTED LIGHT



1 **3996036**

weiß/white/blanc

inkl. 3x LED 4,2 W 460 lm
2.700 K / 4.000 K
4002707445357



2 **3996026**

weiß/white/blanc

inkl. 2x LED 4,2 W 460 lm
2.700 K / 4.000 K
4002707445333



3 **3996016**

weiß/white/blanc

inkl. 1x LED 4,2 W 460 lm
2.700 K / 4.000 K
4002707445302



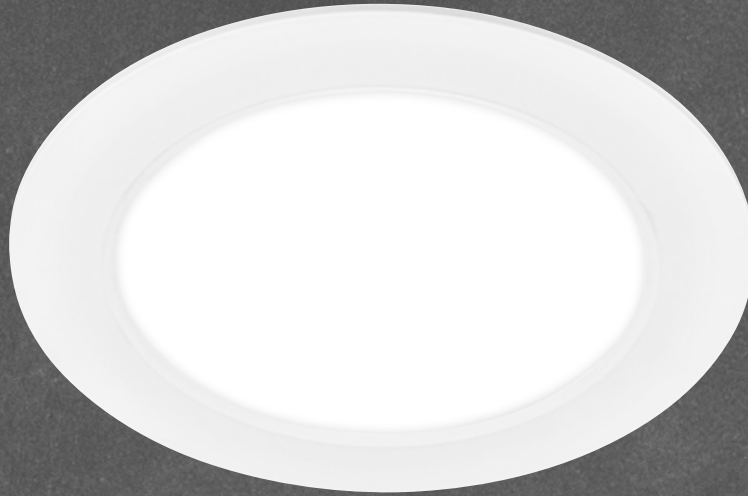

ON
OFF

30MM EINBAUTIEFE | PROFONDEUR D'INSTALLATION | MOUNTING DEPTH



7994016 1

weiß/white/blanc

inkl. LED 12W 1200lm
4.000K
4002707445333

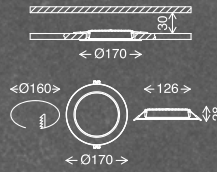

7995016 2

weiß/white/blanc

inkl. LED 12W, 1980lm
4.000K
4002707459033

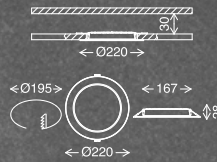

1200
LUMEN

ON
OFF

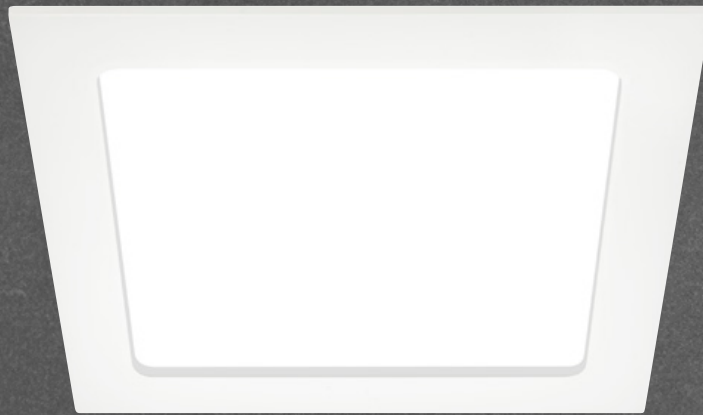

PROFONDEUR D'INSTALLATION | MOUNTING DEPTH | EINBAUTIEFE **40MM**

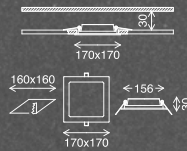

1 **7052-016**

weiß/white/blanc

inkl. LED 12 W 1200 lm
4.000 K
4002707378419

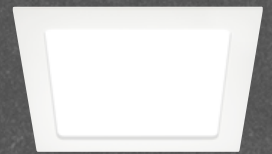

130

BADEZIMMER

BATHROOM
SALLE DE BAIN







Zur optimalen Präsentation am Point of Sale:

For optimal presentation at the point of sale:

Pour une présentation optimale dans vos linéaires:

Wählen Sie die Leuchte nach Ihrem Einsatzwunsch. Sie finden die jeweils ausgezeichnete IP-Schutzart auf jeder Verpackung.

Select your luminaire relevant to the zone where the luminaire is to be installed. You can find the IP rating on each packaging.

Choisissez votre lampe en Fonction de son lieu d'installation. Vous trouverez respectivement une excellente protection IP sur chaque emballage.

≥ IP44
SCHUTZKLEIN-
SPANNUNG < 12V

ZONE
1

IP67
SCHUTZKLEIN-
SPANNUNG < 12V

ZONE
0

≥ IP20

ZONE
3

≥ IP44

ZONE
2

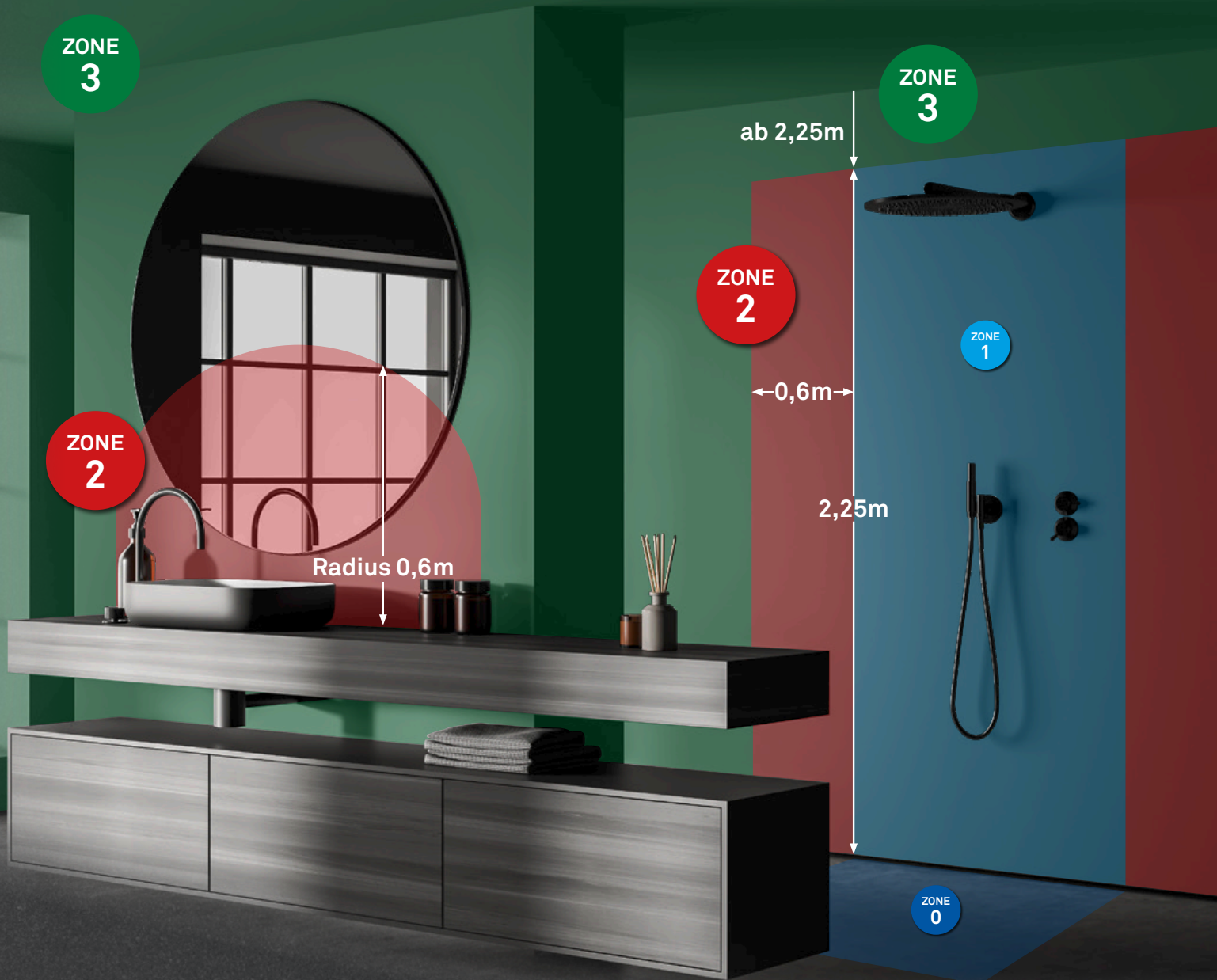



best
in
black



1



3351-015

1

schwarz/black/noir

inkl. LED Platine 12W 1.300lm
4.000K
4002707402886



IP44

2

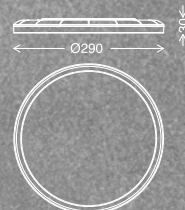
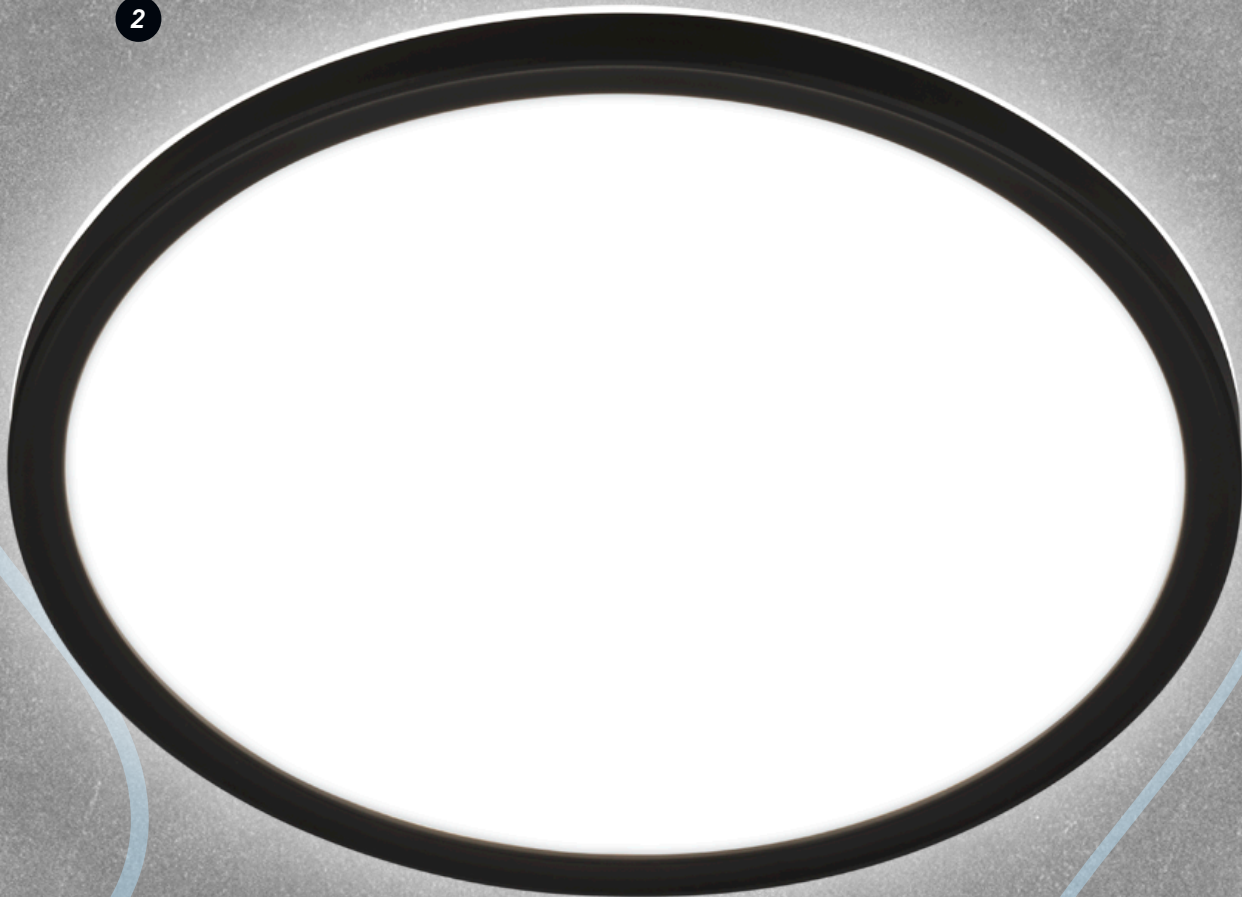

IP44

2

3820415

schwarz/black/noir

inkl. LED 18W 2400lm

4.000K

4002707461937

DUN

best
in
black

Montage auf dem Schrank
Mounting on the cabinet
Montage sur armoire



Montage am Spiegel
Mounting on the mirror
Montage sur miroir

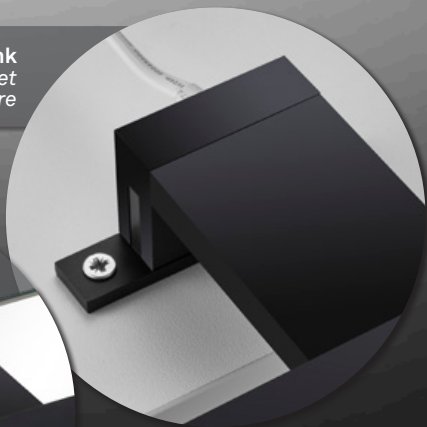



Aufbauelement inkludiert
 Installation element included
 Élément de montage inclus

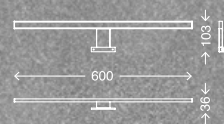
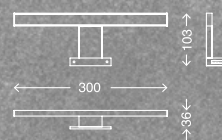

1 **2104-015**

schwarz/black/noir

inkl. LED Platine 5 W 550 lm
 4.000 K
 4002707402855

2 **2104-115**

schwarz/black/noir

inkl. LED Platine 8 W 780 lm
 4.000 K
 4002707402879

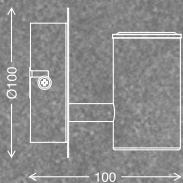

2115015

1

schwarz/black/noir

exkl. 1x E27 / max. 10 W

4002707444213



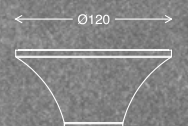
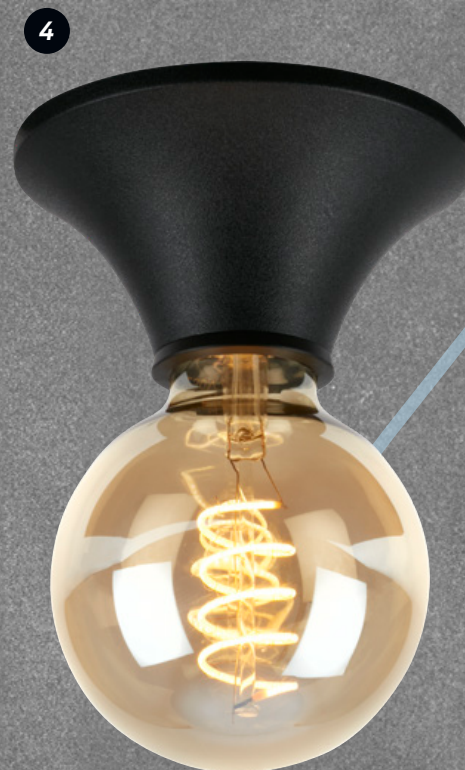
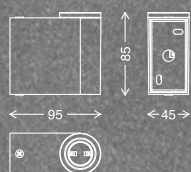
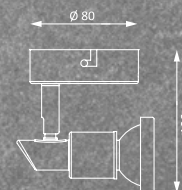

2 **2992-015**
 schwarz/black/noir
 inkl. LED/GU10 4,8W 400lm
 3.000K
 4002707421726

3 **2182015**
 schwarz/black/noir
 exkl. 1x E27 / max. 10W
 4002707461883

4 **2114015**
 schwarz/black/noir
 exkl. 1x E27 / max. 10W
 4002707444190



1

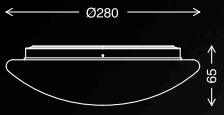
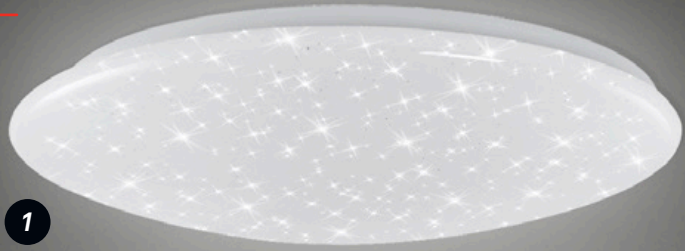

3360-016

1

weiß/white/blanc

inkl. LED 12 W 1.200lm
4.000K
4002707347811





2 **3351-016**

chrom/chrome/chrome

inkl. LED Platine 12W 1.300lm
4.000K
4002707339281

3 **3351-216**

chrom/chrome/chrome

inkl. LED Platine 18W 1.850lm
4.000K
4002707339298

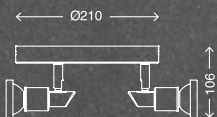
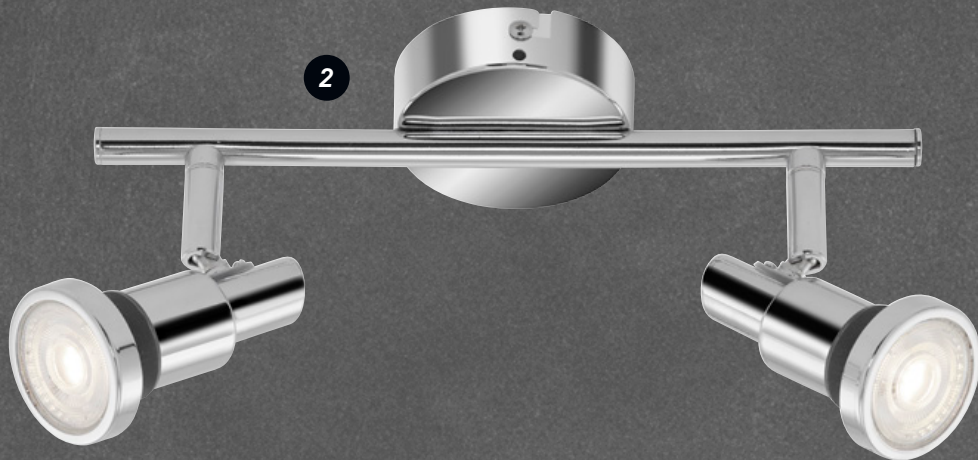
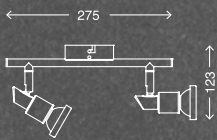
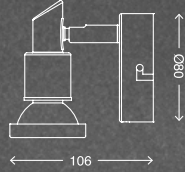

2992-018

1

chrom/chrome/chrome

inkl. 1x LED/GU10 4,8W 1x 400lm
3.000K
4002707338789

2992-028

2

chrom/chrome/chrome

inkl. 2x LED/GU10 4,8W 2x 400lm
3.000K
4002707338796

2992-038R

3

chrom/chrome/chrome

inkl. 3x LED/GU10 4,8W 3x 400lm
3.000K
4002707338802



IP44



5

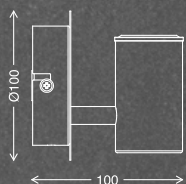

4

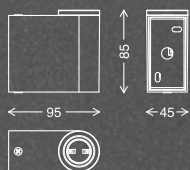

4

2115015

schwarz/black/noir
 exkl. 1x E27 / max. 10W
 4002707444213

5

2115018

chrom/chrome/chrome
 exkl. 1x E27 / max. 10W
 4002707444220



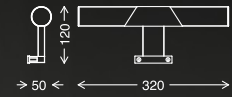
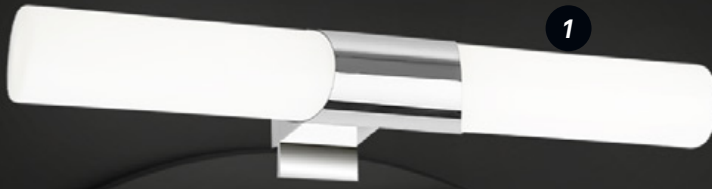

Montage auf dem Schrank
Mounting on the cabinet
Montage sur armoire

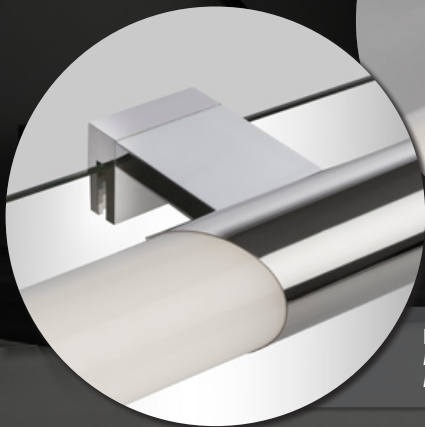
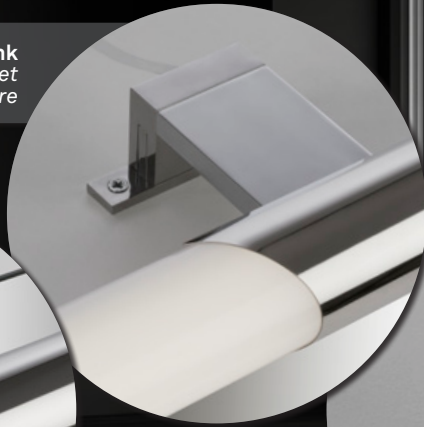

Montage am Spiegel
Mounting on the mirror
Montage sur miroir

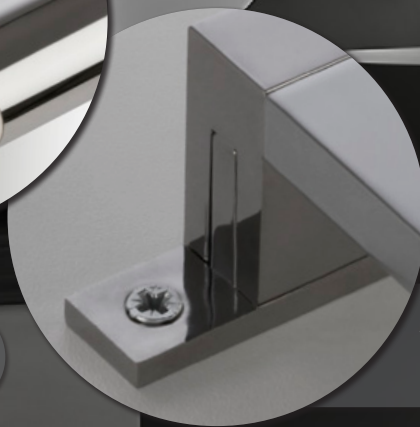

Aufbauelement inkludiert
Installation element included
Élément de montage inclus

2113-018

1

chrom/chrome/chrome

inkl. LED Platine 7 W 800lm
4.000K
4002707422501



IP44

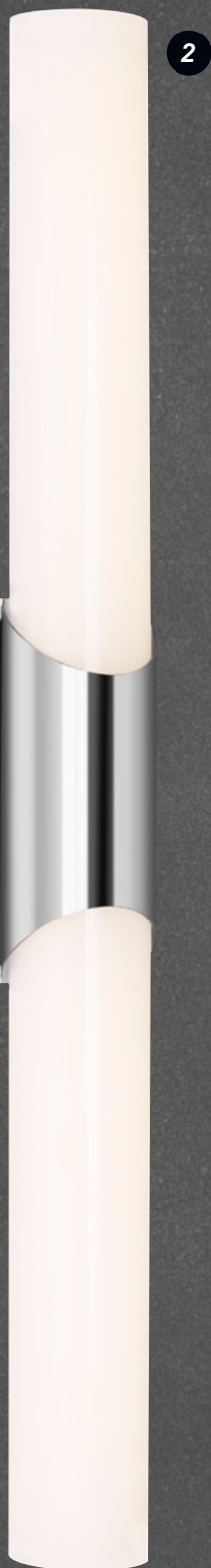
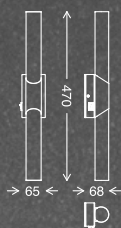

2

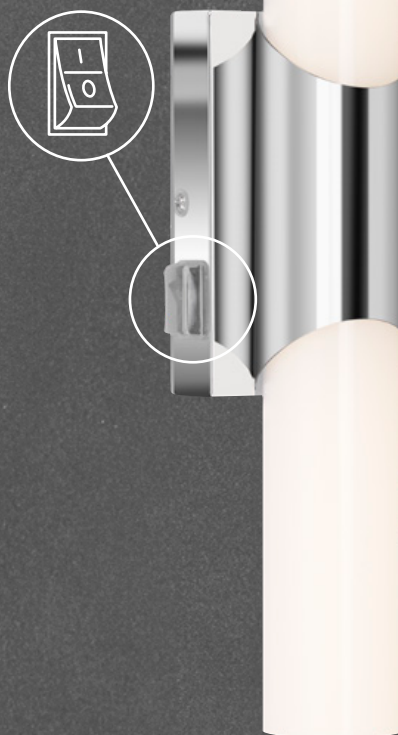

3

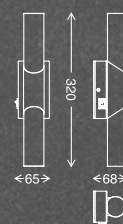

2

2111-118

chrom/chrome/chrome

inkl. LED Platine 11 W 1.300 lm
4.000 K
4002707402992

3

2111-018

chrom/chrome/chrome

inkl. LED Platine 7 W 750 lm
4.000 K
4002707402985



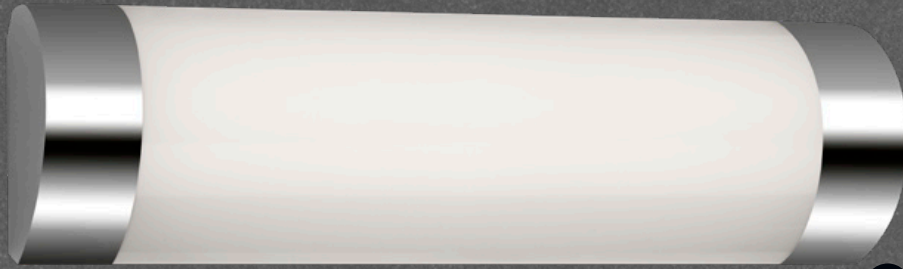

1

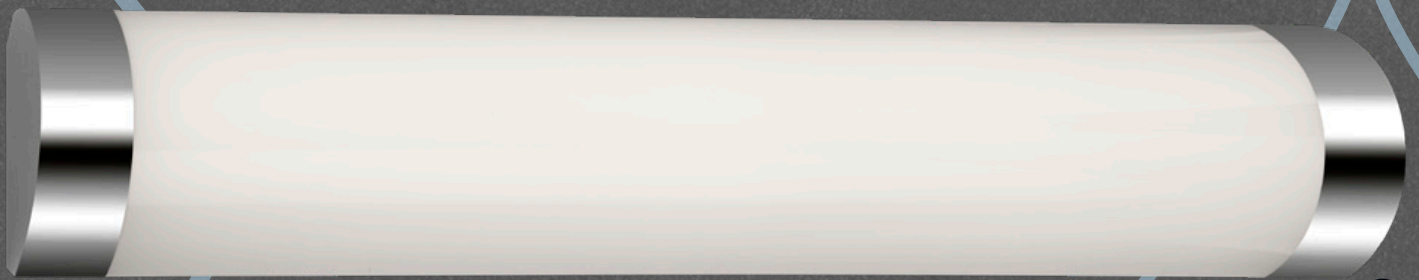
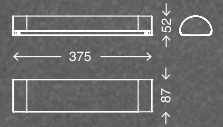

2



1 **2071-018**

chrom/chrome/chrome
inkl. LED Platine 8 W 720lm
4.000 K
4002707338710

2 **2071-118**

chrom/chrome/chrome
inkl. LED Platine 11 W 1.200lm
4.000 K
4002707338727

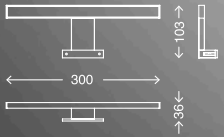
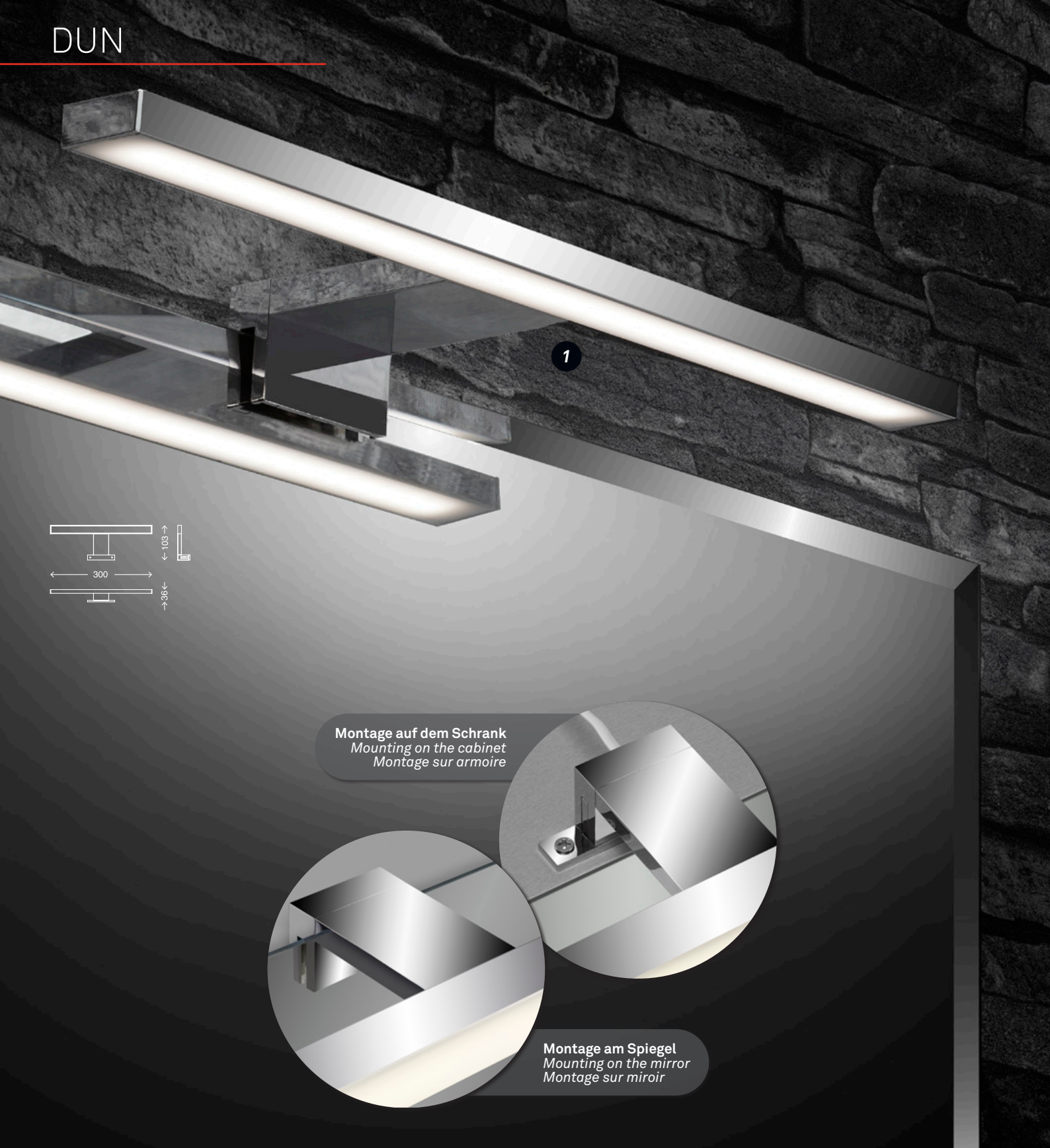

Montage auf dem Schrank
Mounting on the cabinet
Montage sur armoire

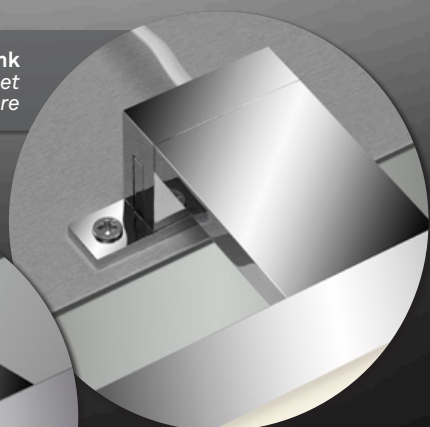
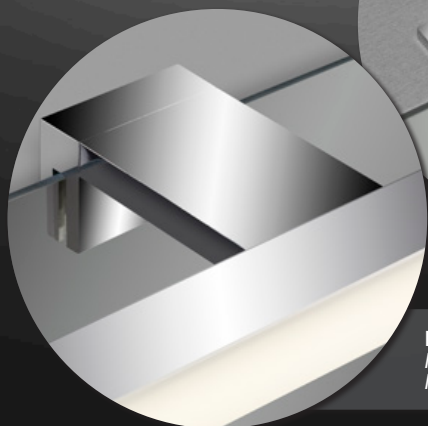

Montage am Spiegel
Mounting on the mirror
Montage sur miroir

2104-018

1

chrom/chrome/chrome

inkl. LED Platine 5 W 550 lm

4.000 K

4002707338758



IP44

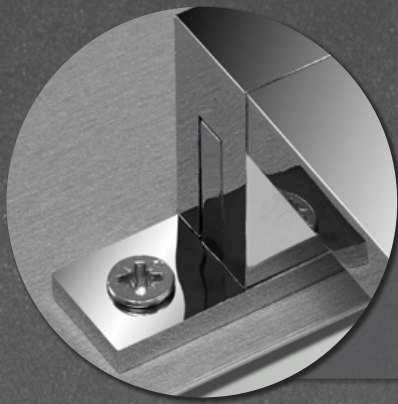

Aufbauelement inkludiert
 Installation element included
 Élément de montage inclus

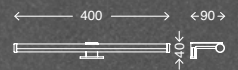
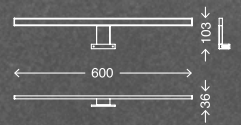

2 **2104-118**

chrom/chrome/chrome

inkl. LED Platine 8 W 780 lm
 4.000 K
 4002707338765

3 **2105-018**

chrom/chrome/chrome

inkl. LED Platine 6 W 600 lm
 4.000 K
 4002707338772



**BACK
LIGHT
EFFECT**

1



3820414

1

chrom-matt/chrome satin/

*inkl. LED 18W 2400lm
4.000K
4002707461944*



IP44

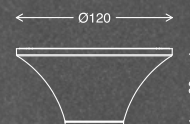
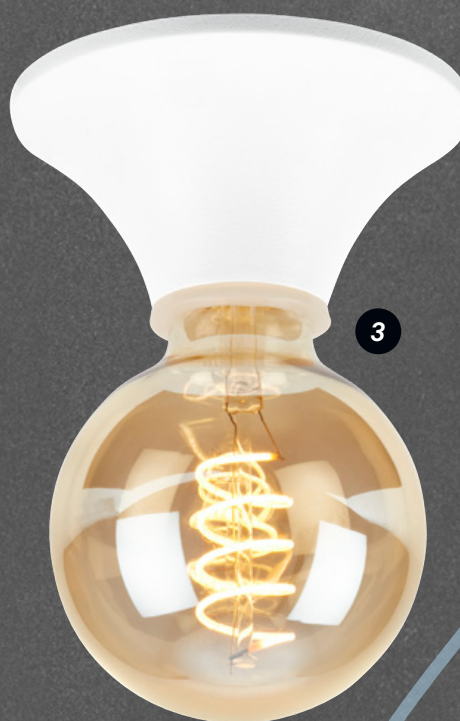

***IP44 nur mit D95 globe**

IP44 only with D95 globe

IP44 uniquement avec globe D95



IP44 *

2

2114014

*chrom-matt/chrome satin/
chrome mat*
exkl. 1x E27 / max. 10 W

4002707444206

3

2114016

weiß/white/blanc
exkl. 1x E27 / max. 10 W

4002707444183

ACORUS BLACK



best
in
black

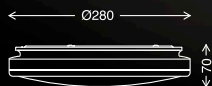

3403-015

1

schwarz/black/noir

inkl. LED Platine 12W 1.200lm
4.000K
4002707386650



IP44



2

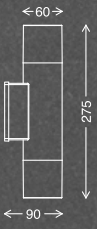

IP44

2

2090025

schwarz/black/noir

*inkl. 2x LED/GU10 4,8 W 400 lm
3.000 K
4002707444480*



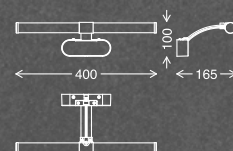
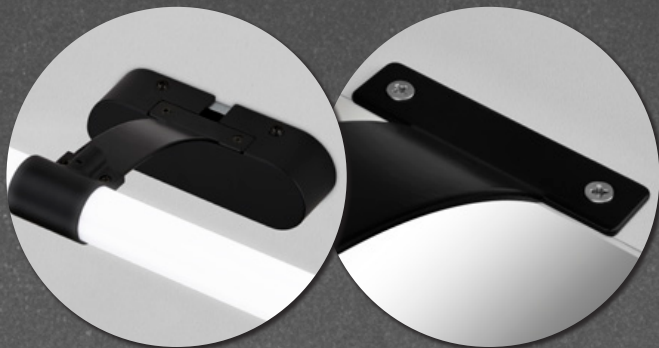

IP44

1

2121015

schwarz/black/noir

*inkl. LED 7 W 690 lm
4.000 K
4002707444268*

2

2116015

schwarz/black/noir

*inkl. LED 7 W 690 lm
4.000 K
4002707444237*

BANYO

best
in
black

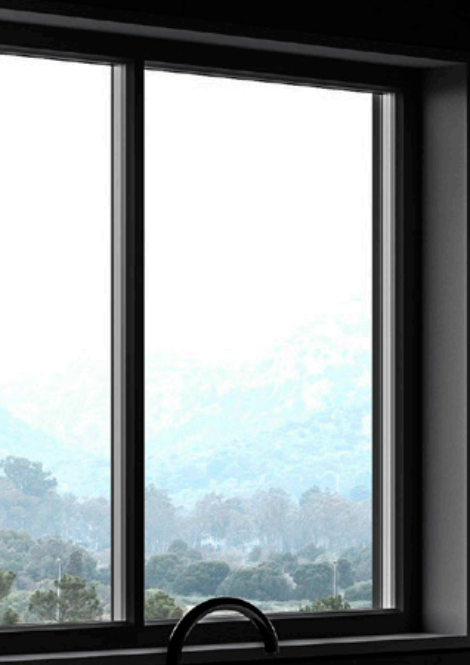

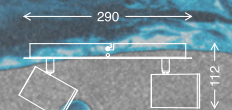
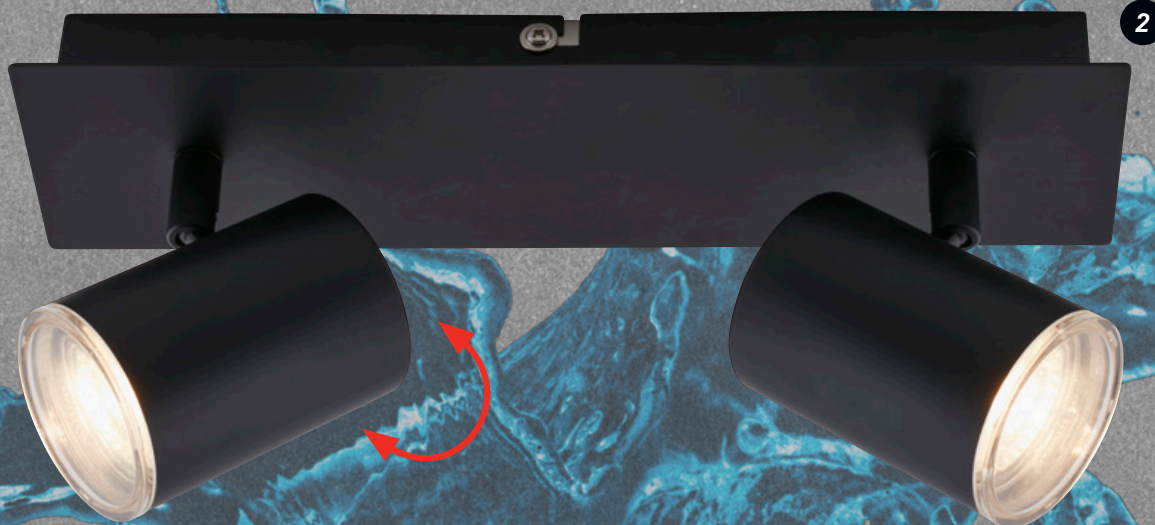
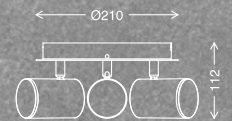

1 **2731-035**

schwarz/black/noir

*exkl. 3x LED/GU10 max. 5W
ohne Leuchtmittel/without bulb/
sans ampoule*

4002707409168

2 **2731-025**

schwarz/black/noir

*exkl. 2x LED/GU10 max. 5W
ohne Leuchtmittel/without bulb/
sans ampoule*

4002707409144

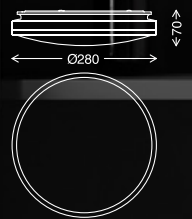

3403-018

1

chrom/chrome/chrome

inkl. LED Platine 12W 1.200lm
4.000K
4002707388715



IP44



2

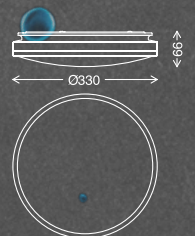

IP44

2

3403-118

chrom/chrome/chrome

inkl. LED Platine 18W 1.850 lm
4.000 K
4002707388807

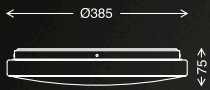
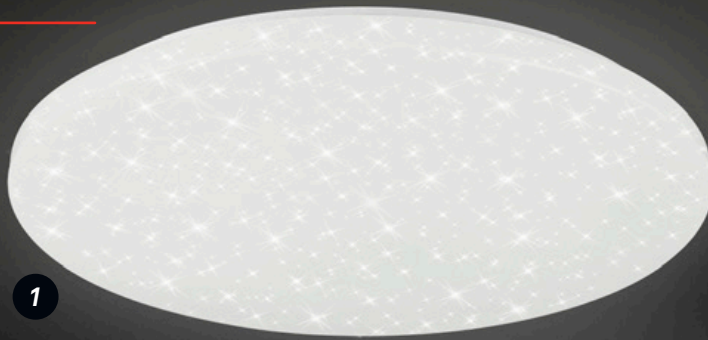

2360-016

1

weiß/white/blanc

inkl. LED Platine 18W 2.200lm
4.000K
4002707403173



IP44



2

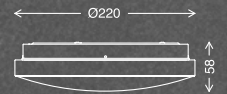

3

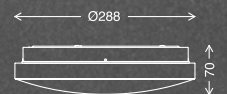

2

3404-016

weiß/white/blanc

inkl. LED Platine 10W 1.100lm
4.000K
4002707386247

3

3404-116

weiß/white/blanc

inkl. LED Platine 12W 1.200lm
4.000K
4002707386254



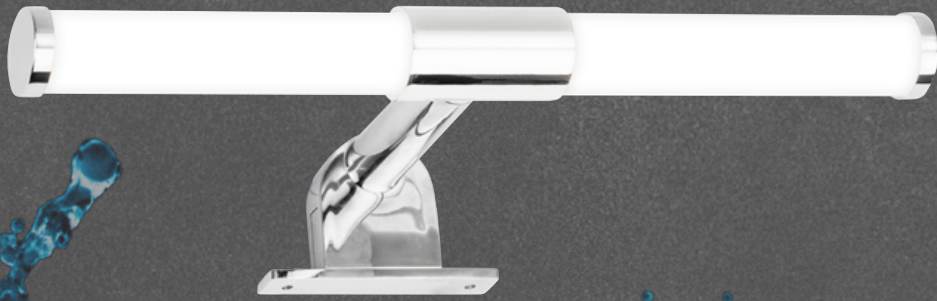
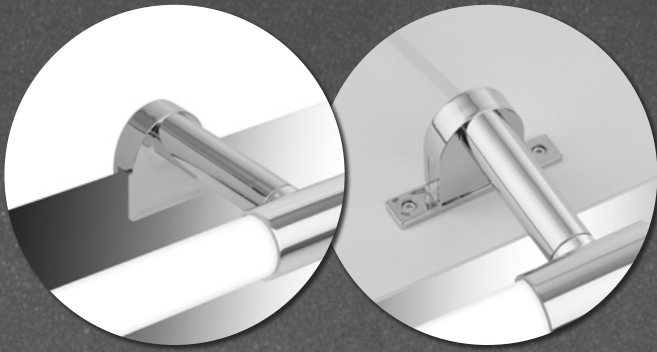

1

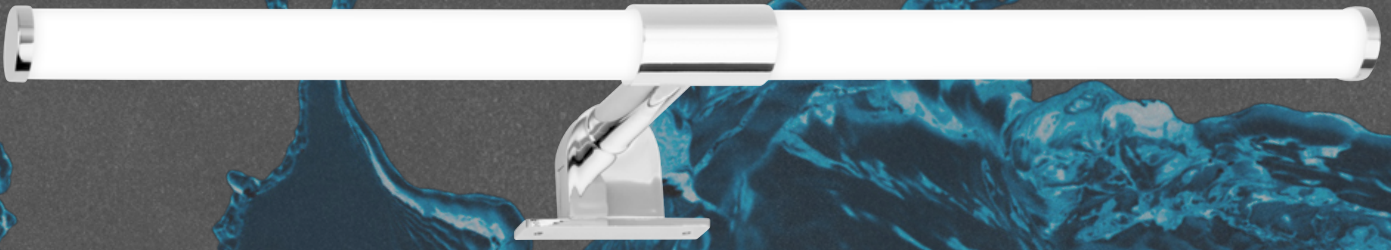
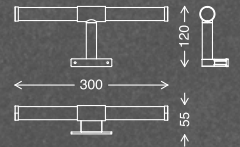

2

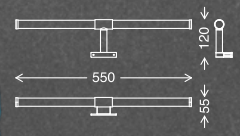

1 **2189018**
 chrom/chrome/chrome
 inkl. LED 5W 550lm
 4.000K
 4002707461913

2 **2189118**
 chrom/chrome/chrome
 inkl. LED 9W 960lm
 4.000K
 4002707461920

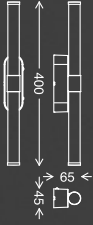

1



2



2116014

1

chrom/chrome/chrome

inkl. LED 7W 690lm
4.000K
4002707444244

2117014

2

chrom/chrome/chrome

inkl. LED 9W 920lm
4.000K
4002707444251



IP44

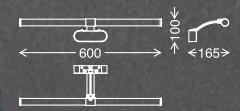
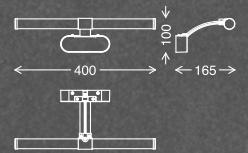
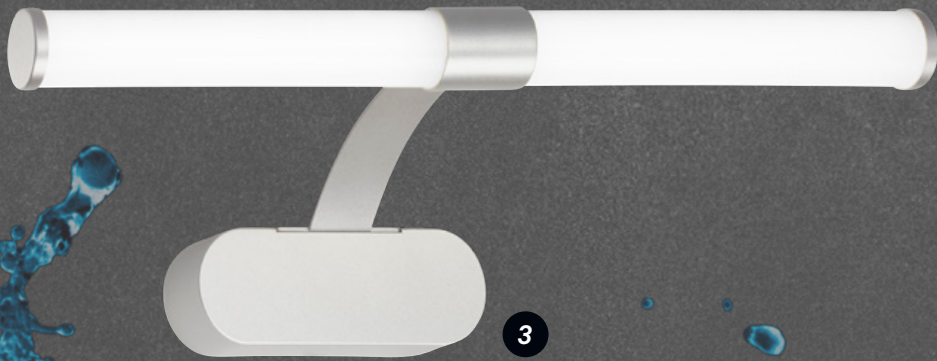

3 **2121014**
 chrom/chrome/chrome
 inkl. LED 7 W 690lm
 4.000K
 4002707444275

4 **2131014**
 chrom/chrome/chrome
 inkl. LED 9 W 920lm
 4.000K
 4002707444282



Montage auf dem Schrank
Mounting on the cabinet
Montage sur armoire



Montage am Spiegel
Mounting on the mirror
Montage sur miroir

**DOUBLE
PACK**

2197026

1

weiß/white/blanc

inkl. 2x LED 3,5W 330 lm
4.000K
4002707461784



IP44



Montage auf dem Schrank
 Mounting on the cabinet
 Montage sur armoire

Montage am Spiegel
 Mounting on the mirror
 Montage sur miroir

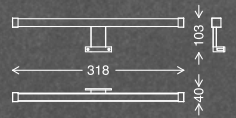
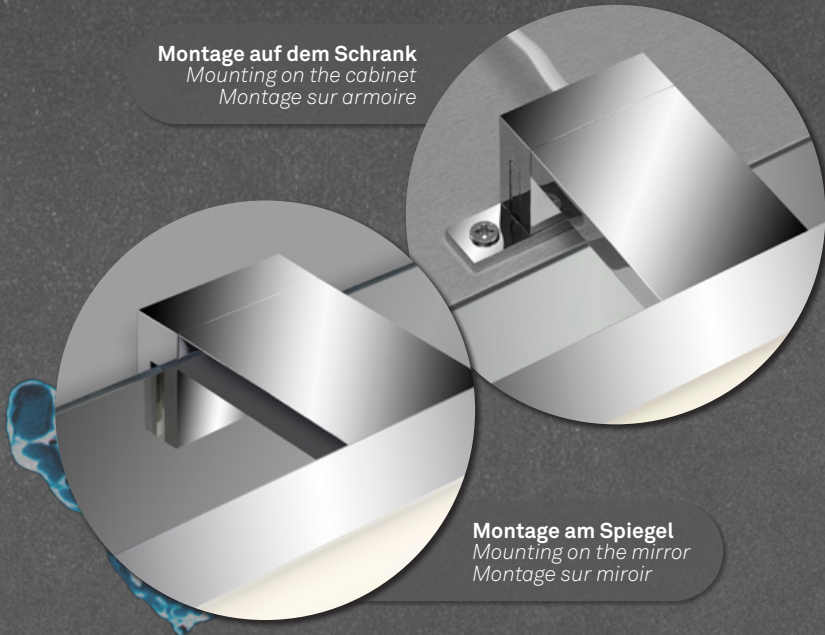

2

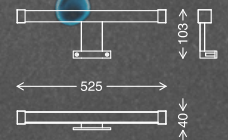
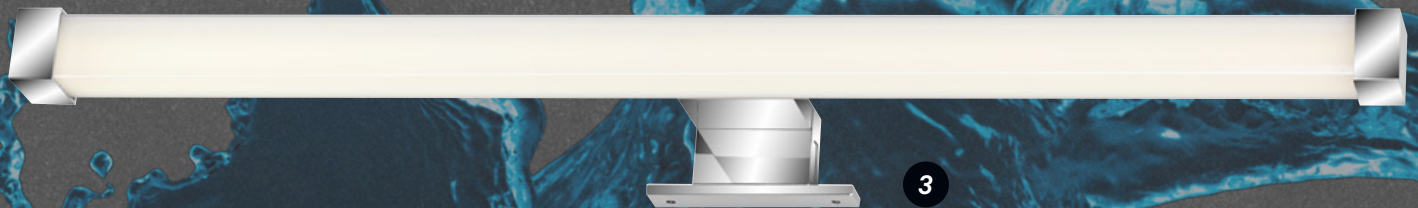

3



2 **2110-018**

chrom/chrome/chrome

inkl. LED 8 W 720lm
 4.000 K
 4002707386612

3 **2110-118**

chrom/chrome/chrome

inkl. LED 10 W 1.200lm
 4.000 K
 4002707386629

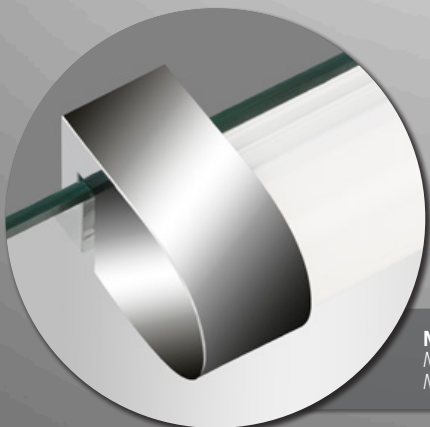

Montage am Spiegel
Mounting on the mirror
Montage sur miroir

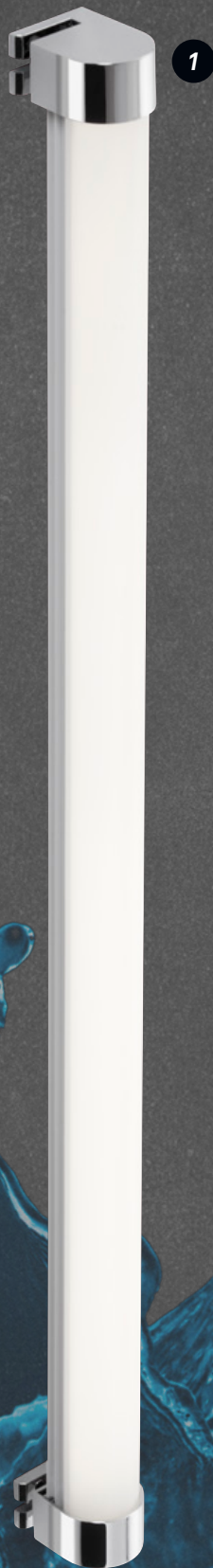

IP44

1 **2062-018**

chrom/chrome/chrome

inkl. LED Platine 10W 1.200lm
4.000K
4002707327950

2 **2059-018**

chrom/chrome/chrome

inkl. LED Platine 8W 800lm
4.000K
4002707327936

SUJOS



2090028

1

chrom/chrome/chrome

inkl. 2x LED/GU10 4,8W 400 lm
3.000K
4002707444497



IP44

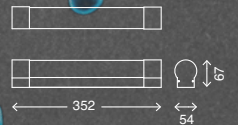
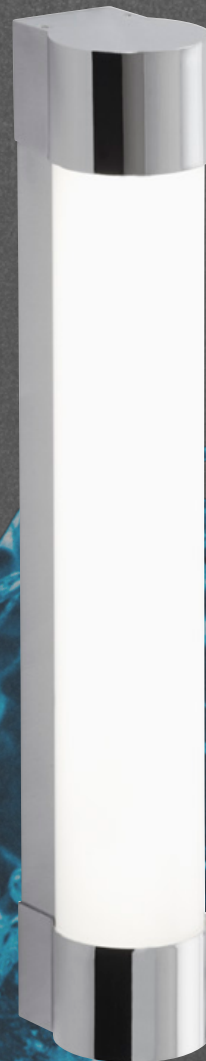

2 **2051-118**

chrom/chrome/chrome

inkl. LED Platine 10 W 1.000 lm
4.000 K
4002707327004

3 **2051-018**

chrom/chrome/chrome

inkl. LED Platine 8 W 800 lm
4.000 K
4002707326991



1

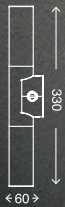

2148-028

1

chrom/chrome/chrome

exkl. 2x E14 / max. 9W
ohne Leuchtmittel/without bulb/
sans ampoule

4002707205609



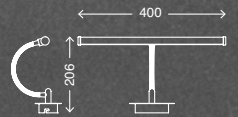

2

2057-018

chrom/chrome/chrome

inkl. LED Platine 5,5 W 550 lm
3.000 K
4002707327431



174 FUNKTIONALES LICHT

FUNCTIONAL LIGHTING
ÉCLAIRAGE FONCTIONNEL





- **Inkl. Flexarm**
Incl. flex arm
Bras flexible inclus
- **Kein Wandanschluss erforderlich**
No wall connection required
Aucun raccordement mural requis
- **Einfache Montage**
Simple assembly
Montage simple
- **Ein/Aus Schalter am Leuchtenfuß**
On/off switch on lamp base
Interrupteur sur le pied de la lampe

2180015

1

schwarz/black/noir

inkl. LED/GU10 4,8W 400lm
3.000K
4002707446156



**BACK
LIGHT
EFFECT**



**Backlight und Spot
getrennt schaltbar**

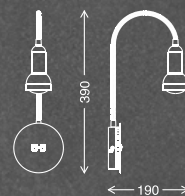

2

2178015

schwarz/black/noir
inkl. LED 2,5 W 150 lm
exkl. E14/R50 max 10 W
2.700 K
4002707446279

3

2178012

matt-nickel/satin nickel/nickel mat
inkl. LED 2,5 W 150 lm
exkl. E14/R50 max 10 W
2.700 K
4002707446293



Leuchte montieren

Mount the light
Monter le luminaire



Stecker einstecken

Plug in the power connection
Brancher la prise



Fertig!

Finished!
Terminé!

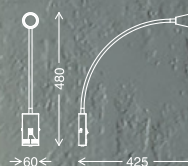

2175015

1

schwarz/black/noir

exkl. 1x GU10 max. 9W
inkl. 2x USB 5V 0,9A 4,5W
4002707459842

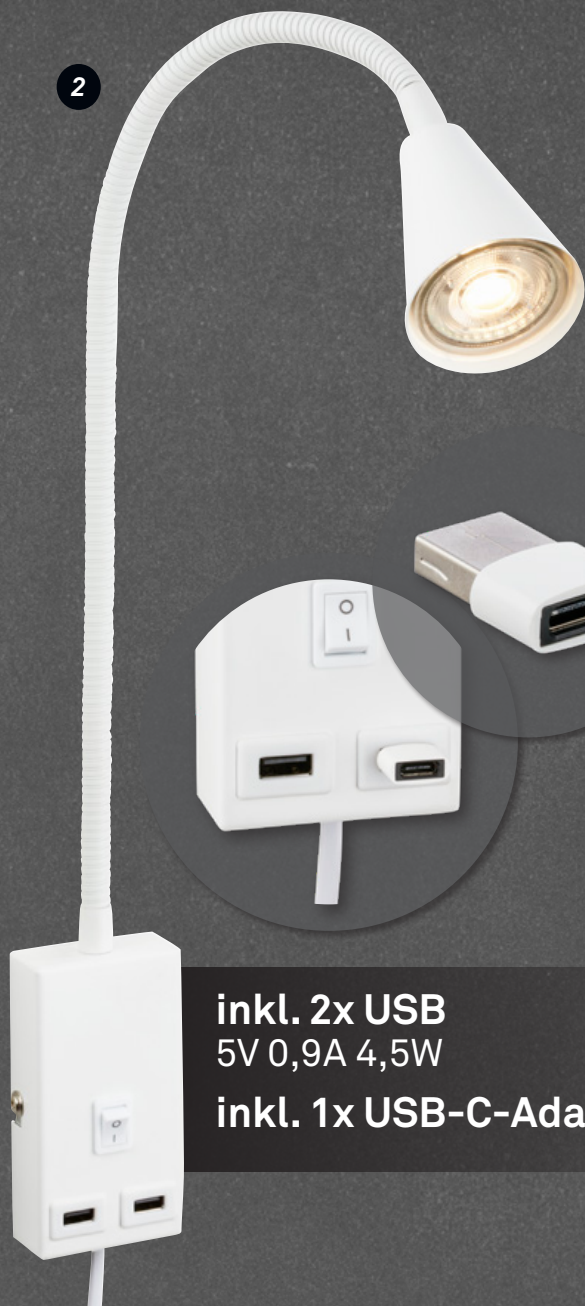

2

inkl. 2x USB
5V 0,9A 4,5W
inkl. 1x USB-C-Adapter

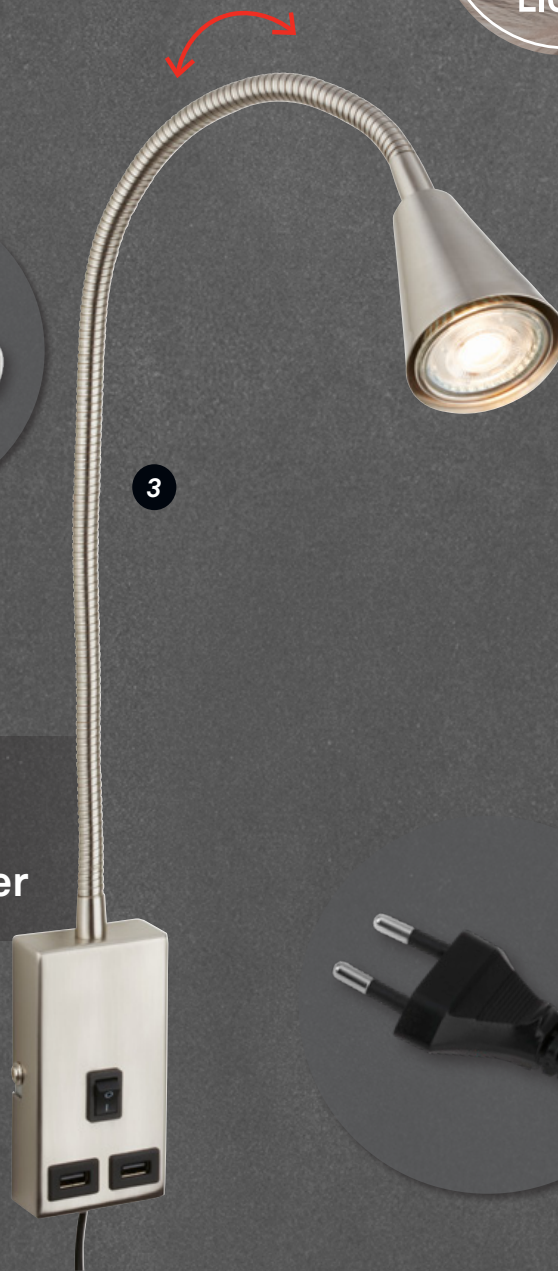
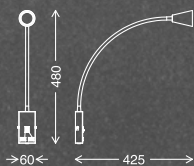

3

2

2175016

schwarz/black/noir

exkl. 1x GU10 max. 9W
inkl. 2x USB 5V 0,9A 4,5W
4002707459859

3

2175012

matt-nickel/satin nickel/nickel mat

exkl. 1x GU10 max. 9W
inkl. 2x USB 5V 0,9A 4,5W
4002707459866

- **Inkl. Zuleitung mit Stecker**
Incl. supply cable with plug
Câble d'alimentation et fiche électrique incl.
- **Kein Wandanschluss erforderlich**
No wall connection required
Aucun raccordement mural requis
- **Einfache Montage**
Simple assembly
Montage simple
- **Touchsensor - An/Aus durch Berühren der Fläche**
Touch sensor – Touch the surface to switch on/off
Détecteur tactile - Marche/Arrêt en touchant sa surface





3

2

1

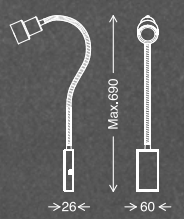

1 **2085-012**
 matt-nickel/satin nickel/
 nickel mat
 inkl. LED/GU10 4,7 W 400 lm
 3.000 K
 4002707407737

2 **2085-015**
 schwarz/black/noir
 inkl. LED/GU10 4,7 W 400 lm
 3.000 K
 4002707407744

3 **2085-016**
 weiß/white/blanc
 inkl. LED/GU10 4,7 W 400 lm
 3.000 K
 4002707407751



 **Leuchte montieren**

*Mount the light
Monter le luminaire*

 **Stecker einstecken**

*Plug in the power connection
Brancher la prise*

 **Fertig!**

*Finished!
Terminé!*

2080-012

1

*matt-nickel/satin nickel/
nickel mat
inkl. 1x LED/GU10 4,7W 350lm
3.000K
4002707347132*

2080-015

2

*schwarz/black/noir
inkl. 1x LED/GU10 4,7W 350lm
3.000K
4002707367086*

2080-016

3

*weiß/white/blanc
inkl. 1x LED/GU10 4,7W 350lm
3.000K
4002707367093*



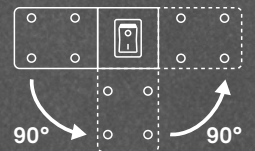

Montagewinkel einstellbar
 Adjustable mounting bracket
 Angle de montage réglable



2084-015

1

schwarz-gold
exkl. 1 x E14 max. 25W

4002707407720



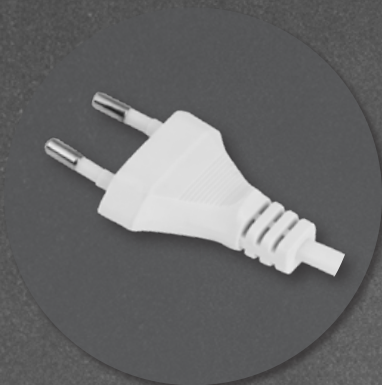

2



3



4

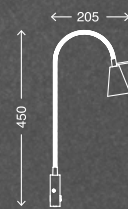

2

2082-012

*matt-nickel/satin nickel/
nickel mat*
inkl. 1x LED/GU10 4,7 W 350 lm
3.000 K
4002707348924

3

2082-015

schwarz/black/noir
inkl. 1x LED/GU10 4,7 W 350 lm
3.000 K
4002707367062

4

2082-016

weiß/white/blanc
inkl. 1x LED/GU10 4,7 W 350 lm
3.000 K
4002707367079



Leuchte montieren

*Mount the light
Monter le luminaire*



Stecker einstecken

*Plug in the power connection
Brancher la prise*



Fertig!

*Finished!
Terminé!*





1 **2089-014**

chrom-matt/chrome-satin/
chrome mat
excl. 1x E27 max. 10 W
ohne Leuchtmittel/without bulb/
sans ampoule

4002707423317

2 **2089-015**

schwarz/black/noir
excl. 1x E27 max. 10 W
ohne Leuchtmittel/without bulb/
sans ampoule

4002707423300

3 **2089-016**

weiß/white/blanc
excl. 1x E27 max. 10 W
ohne Leuchtmittel/without bulb/
sans ampoule

4002707423324



2176016

1

weiß/white/blanc

inkl. 1x LED-Platine 2,4W 290lm,
3000K
4002707459897

2176015

2

schwarz/black/noir

inkl. 1x LED-Platine 2,4W 290lm,
3000K
4002707459903



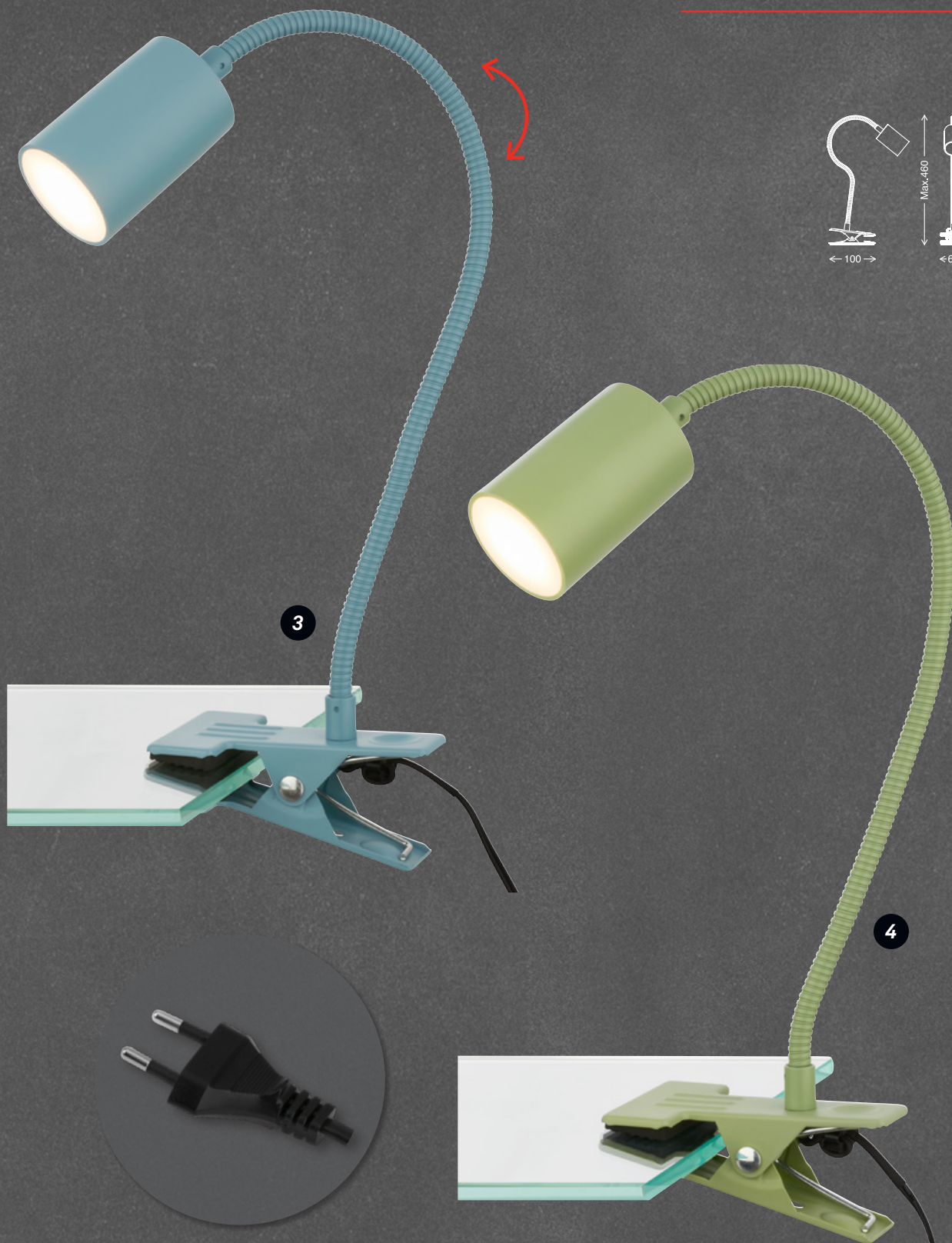

3

2176010

taubenblau/dove blue/bleu colomba

inkl. 1x LED-Platine 2,4W 290lm,
3000K
4002707459910

4

2176019

lindgrün/lime green/vert citron

inkl. 1x LED-Platine 2,4W 290lm,
3000K
4002707459927

ELASTI



1



2

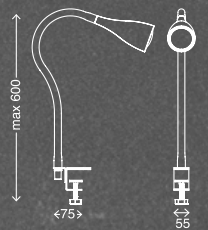
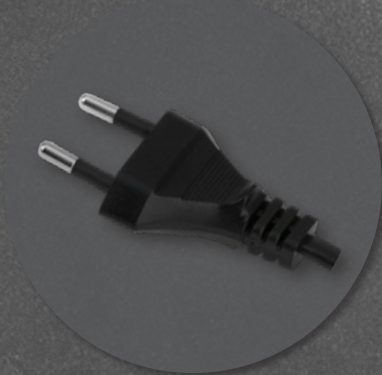

2762-015P

1

schwarz/black/noir

*inkl. 1x LED/GU10 2,9W 260 lm
3.000 K
4002707260608*

2762-016P

2

weiß/white/blanc

*inkl. 1x LED/GU10 2,9W 260 lm
3.000 K
4002707260615*





3



4

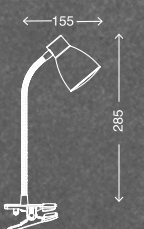

3

2615-014P

titanfarbig/titan colour/
couleur titane
inkl. LED Platine 2,2 W 250 lm
3.000 K
4002707235163

4

2615-016P

weiß/white/blanc
inkl. LED Platine 2,2 W 250 lm
3.000 K
4002707233848

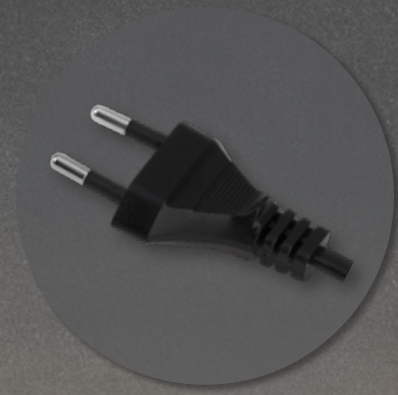

1



2

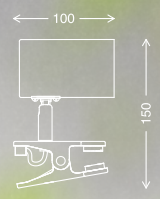

3

2766014

1

chrom-matt/chrome-satin/
chrome mat

exkl. 1x GU10, max. 9W
4002707459835

2766016

2

weiß/white/blanc

exkl. 1x GU10, max. 9W
4002707459828

2766015

3

schwarz/black/noir

exkl. 1x GU10, max. 9W
4002707459811



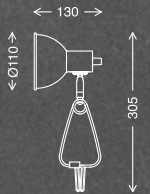
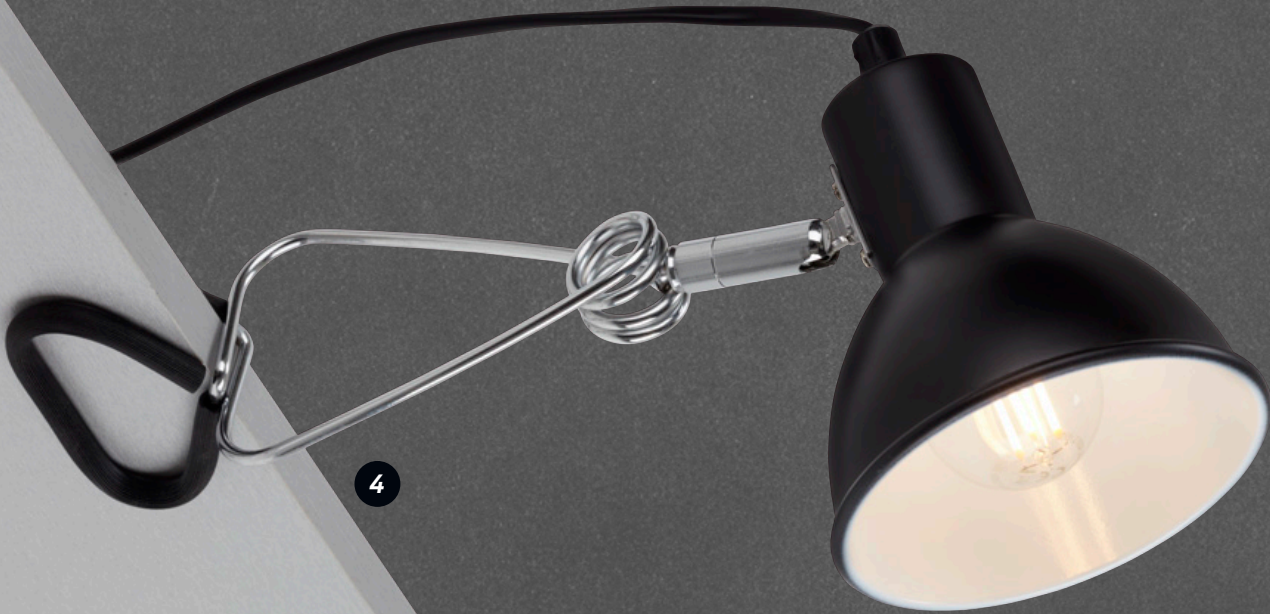
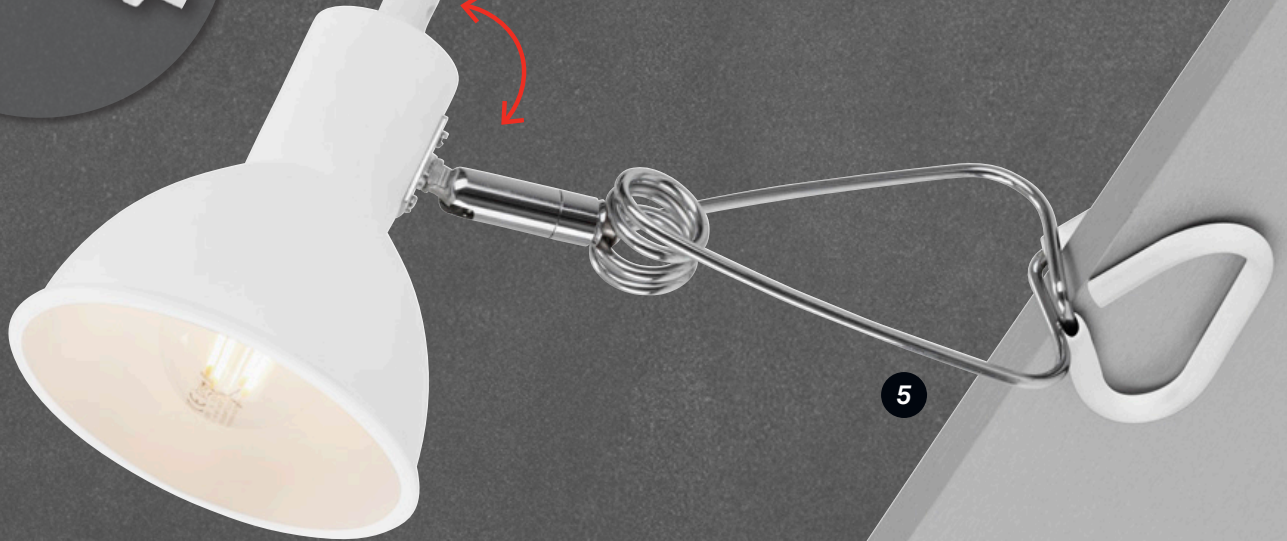
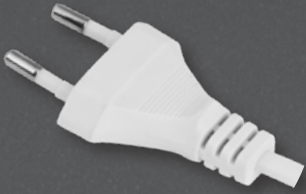

4 **2790-015**

schwarz/black/noir

exkl. 1x E14 / max. 8W
ohne Leuchtmittel/without bulb/
sans ampoule

4002707384601

5 **2790-016**

weiß/white/blanc

exkl. 1x E14 / max. 8W
ohne Leuchtmittel/without bulb/
sans ampoule

4002707384595



1



2

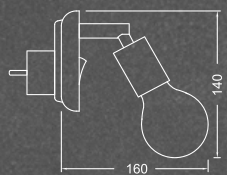

3



2739-014P

1

titanfarbig/titan coloured/
couleure titane
exkl. 1x E14 / max. 25 W
ohne Leuchtmittel/without bulb/
sans ampoule

4002707149002

2739-016P

2

weiß/white/blanc
exkl. 1x E14 / max. 25 W
ohne Leuchtmittel/without bulb/
sans ampoule

4002707183341

2602-015

3

schwarz/black/noir
exkl. 1x E27 / max. 25 W
ohne Leuchtmittel/without bulb/
sans ampoule

4002707403616



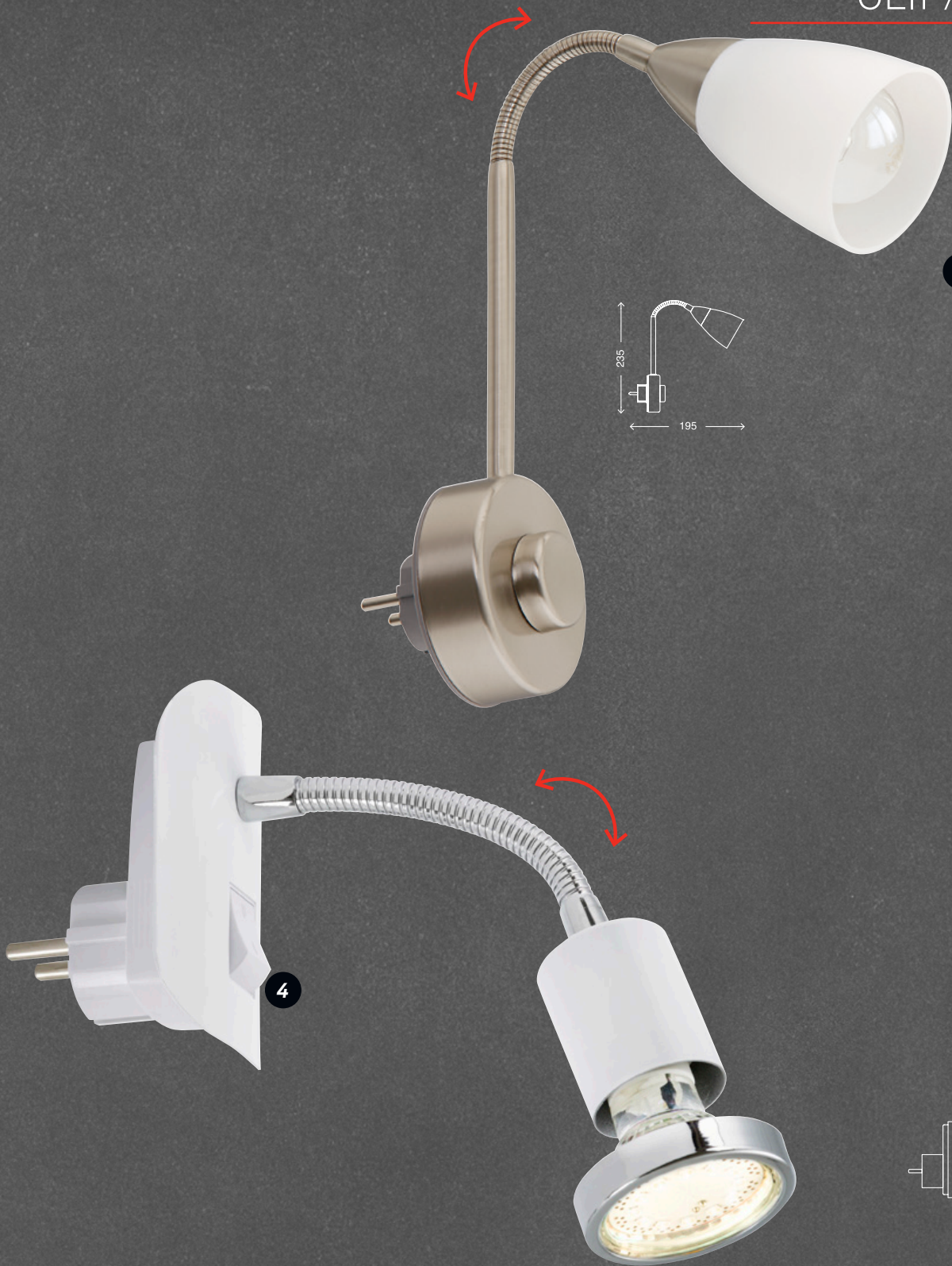

5

4

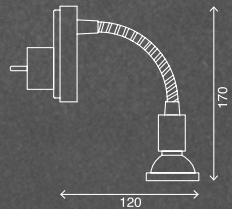

4

2892-016P

weiß/white/blanc
inkl. LED/GU10 2,9W 260lm
3.000K
4002707302247

5

2491-012P

matt-nickel/satin nickel/
nickel mat
exkl. 1 x E14, max 25W
4002707302254



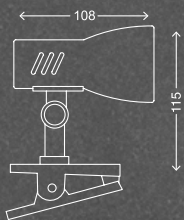
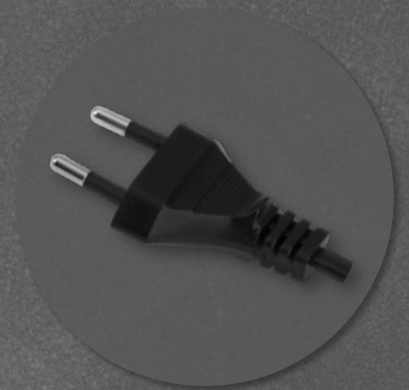

2794-010P

1

blau/blue/bleu

exkl. 1x E14 / max. 40 W
ohne Leuchtmittel/without bulb/
sans ampoule

4002707128243

2794-016P

2

weiß/white/blanc

exkl. 1x E14 / max. 40 W
ohne Leuchtmittel/without bulb/
sans ampoule

4002707108252

2794-014P

3

titanfarbig/titan colour/
couleur titane

exkl. 1x E14 / max. 40 W
ohne Leuchtmittel/without bulb/
sans ampoule

4002707108245





4 2763-016P

weiß/white/blanc

exkl. 1x E14 / max. 25 W
ohne Leuchtmittel/without bulb/
sans ampoule

4002707156116

5 2713-016P

weiß/white/blanc

exkl. 1x E14 / max. 40 W
ohne Leuchtmittel/without bulb/
sans ampoule

4002707190530

6 2603-015

weiß/white/blanc

exkl. 1x E14 / max. 25 W
ohne Leuchtmittel/without bulb/
sans ampoule

4002707407997

Stromloser LED-Komfort und Sicherheit für Innen und Außen! Licht wie Sie es brauchen mit selbsterklärenden Informationen auf der Verpackung.

*Electricity-free LED comfort and security for indoor and outdoor!
Light as you need it with self-explanatory information on the packaging.*

*Confort et sécurité LED sans électricité pour l'intérieur et l'extérieur !
Léger comme vous en avez besoin avec des informations explicites sur l'emballage.*



Sensor

Sensor
Capteur

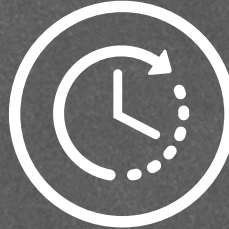

Timer

Timer
Minuteur



Automatisch An/Aus

Automatic on/off
Automatique on/off



Schalter

Switch
Interrupteur



Pushschalter

Push switch
Interrupteur poussoir



Batterie inklusive

Battery inclusive
Pile y compris



Tastsensor

Touch sensor
Capteur tactile



Montagematerial inkl.

Mounting material incl.
Matériel de montage incl.



Leuchtdauer

Illumination time
Temps d'éclairage

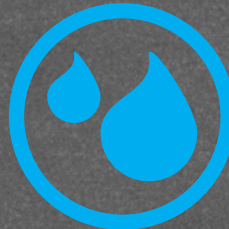

Schutzart

Protection class
Classe de protection



Lero Innen

Lero Indoor
Lero intérieur



Lero Außen

Lero Outdoor
Lero extérieur



VERPACKUNGS-KONZEPT

Wir stellen um und lösen 2 Millionen Blister durch Kartonverpackungen ab. Beim Versandschutz von Europaletten mit Ware und Warenträgern stellen wir von Folie auf Überkartons um. **Weniger ist Pappe!**

PACKAGING CONCEPT

We are replacing 2 million blister packs with carton packaging. For shipping protection of Euro pallets with goods and goods carriers, we are switching from foil to over-cartons. **Less is carton!**

CONCEPT D'EMBALLAGE

Nous remplaçons 2 millions de blisters par des emballages en carton. Pour la protection de l'expédition de marchandises sur europalettes, nous passons du plastique à bulles au carton. **Le carton c'est mieux!**



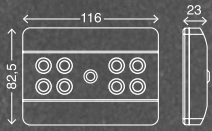

30 sec.



1

2



2255-081

1

silberfarbig/silver coloured/
couleur argenté
inkl. 8x LED 0,08 W 7 lm
6.500 K
4002707227779

2255-086

2

weiß/white/blanc
inkl. 8x LED 0,08 W 7 lm
6.500 K
4002707243212



inkl.

inkl.



- **Integrierter Bewegungssensor**
Integrated motion sensor
Détecteur de mouvement intégré
- **Hell-/Dunkelsensor**
Light/dark sensor
Capteur de luminosité/d'obscurité
- **Erfassungsbereich 3m**
Detection range 3m
Champ de détection 3m
- **Erfassungswinkel 80°-100°**
Detection angle 80°-100°
Angle de détection 80°-100°
- **Leuchtdauer 30 Sekunden**
Illumination time 30 seconds
Durée d'éclairage 30 secondes



3



3

2255-085

schwarz/black/noir

inkl. 8x LED 0,08 W 7 lm
6.500 K
4002707423430



1 min.
5 min.
15 min.



OFF
AUTO
ON

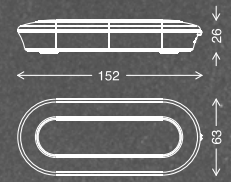

1



2



2281-014

1

silberfarbig/silver coloured/
couleur argenté
inkl. 1x LED 1,5 W 133 lm
6.500 K
4002707386094

2280-014

2

silberfarbig/silver coloured/
couleur argenté
inkl. 1x LED 0,4 W 68 lm
6.500 K
4002707386087



inkl.

inkl.



3



4



inkl.



inkl.

3

2268-061

titanfarbig/titan colour/
couleur titane
inkl. 6x LED 0,08 W 5 lm
6.500 K
4002707232278

4

2268-065

schwarz/black/noir
inkl. 6x LED 0,08 W 5 lm
6.500 K
4002707423393

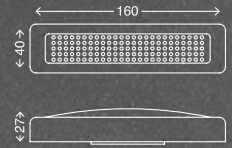

1



2



2689-034

1

titanfarbig/titan colour/
couleur titane
inkl. 3x LED 0,06 W 5lm
6.500 K
4002707239758

2689-035

2

schwarz/black/noir
inkl. 3x LED 0,06 W 5lm
6.500 K
4002707423386



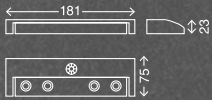

3

2269-041

titanfarbig/titan colour/
couleur titane
inkl. 4x LED 0,08 W 5 lm
6.000 K
4002707232285

4

2251-034

titanfarbig/titan colour/
couleur titane
inkl. 3x LED 0,3 W 15 lm
6.500 K
4002707386049

TIRI/ QUIRI

1 min.
5 min.
15 min.

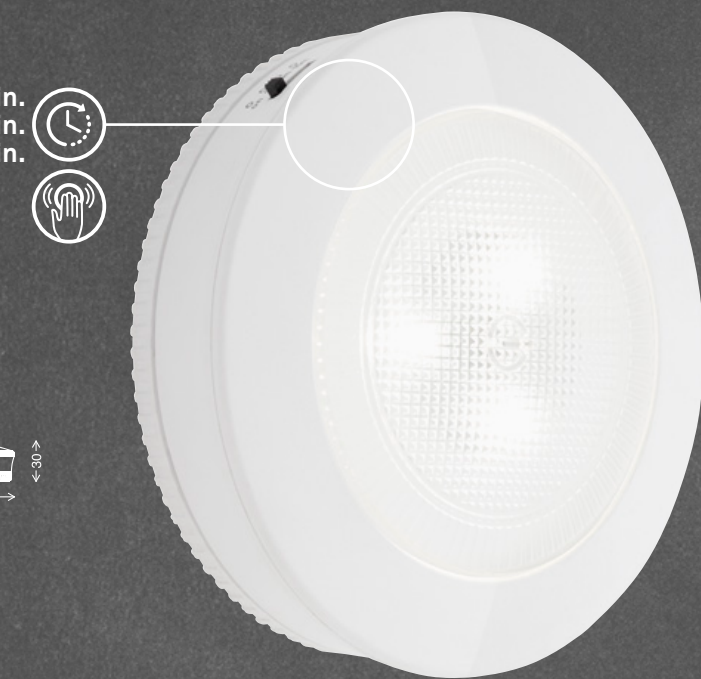

1



2

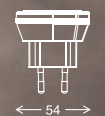

2274-016

1

weiß/white/blanc

inkl. LED 0,4 W 63 lm
6.500 K
4002707386070

2199-016

2

weiß/white/blanc

inkl. LED 0,4 W 1,5 lm
3.000 K
4002707409243



inkl.





20 sec.

3

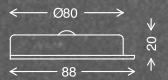

4



3 2273-016

weiß/white/blanc

inkl. LED 0,8 W 30 lm
6.500 K
4002707386063

4 2272-016

weiß/white/blanc

inkl. LED 0,4 W 30 lm
6.500 K
4002707386056

Stromlose Beleuchtung für mehr Sicherheit, auch in den dunkelsten Ecken!

Powerless lighting for improved safety, even in the darkest corners!

Un éclairage sans courant pour plus de sécurité, même dans les coins les plus sombres !



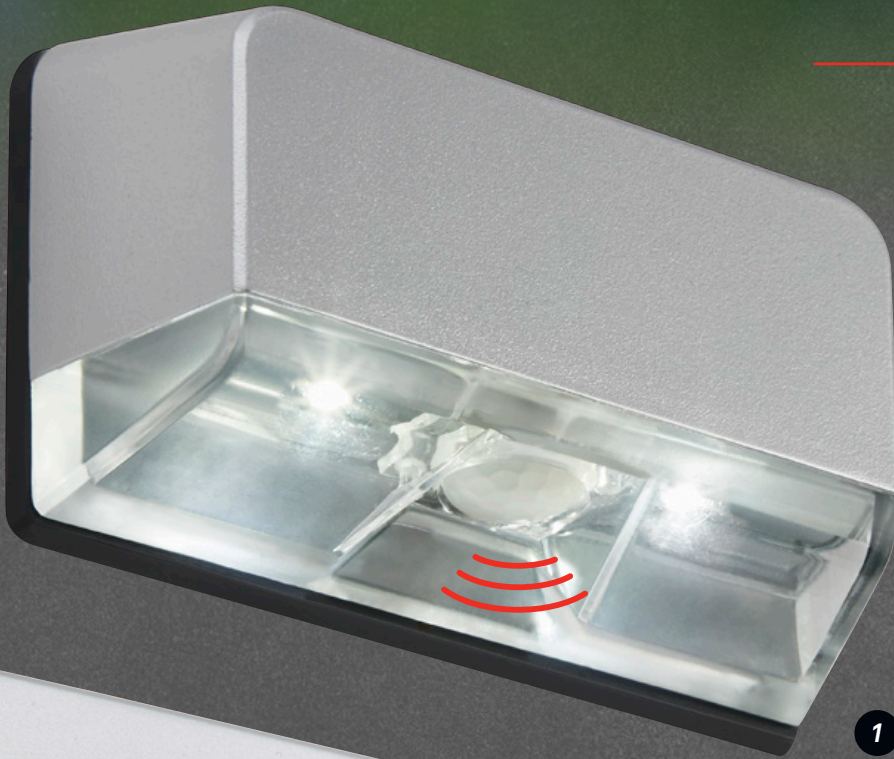

1



45 sec.



2

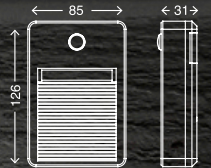

1 **2277-021**

silberfarbig/silver coloured/
couleur argenté
inkl. 2x LED 0,06 W 6 lm
6.500 K
4002707237655

2 **2278-031**

titanfarbig-silber/titan colour-silver/
couleur titane-argenté
inkl. 3x LED 0,06 W 5 lm
6.500 K
4002707237662



2276-061

1

titanfarbig-silber/titan colour-
silver/ couleur titane-argenté
inkl. 6x LED 0,06 W 7 lm
6.500 K
4002707237648

2276-066

2

weiß/white/blanc
inkl. 6x LED 0,06 W 7 lm
6.500 K
4002707243205



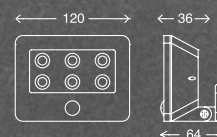

- **Integrierter Bewegungssensor**
Integrated motion sensor
Détecteur de mouvement intégré
- **Reflektor schwenkbar**
Reflector pivotable
Réflecteur inclinable
- **Erfassungsbereich 3m**
Detection range 3m
Champ de détection 3m
- **Erfassungswinkel 80°-100°**
Detection angle 80°-100°
Angle de détection 80°-100°
- **Leuchtdauer 45 Sekunden**
Illumination time 45 seconds
Durée d'éclairage 45 secondes



inkl.



inkl.

3

2276-065

schwarz/black/noir

inkl. 6x LED 0,06 W 7 lm
6.500 K
4002707423423

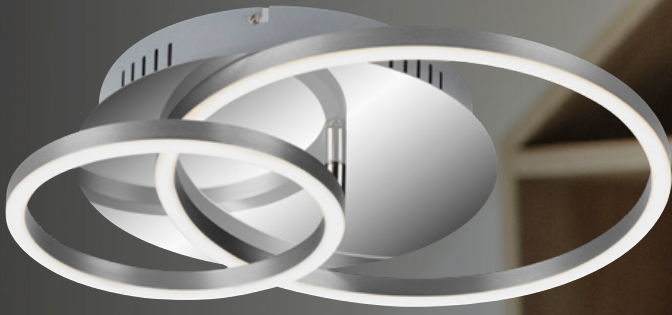

212 FRAMES





FRAME NESTED



1

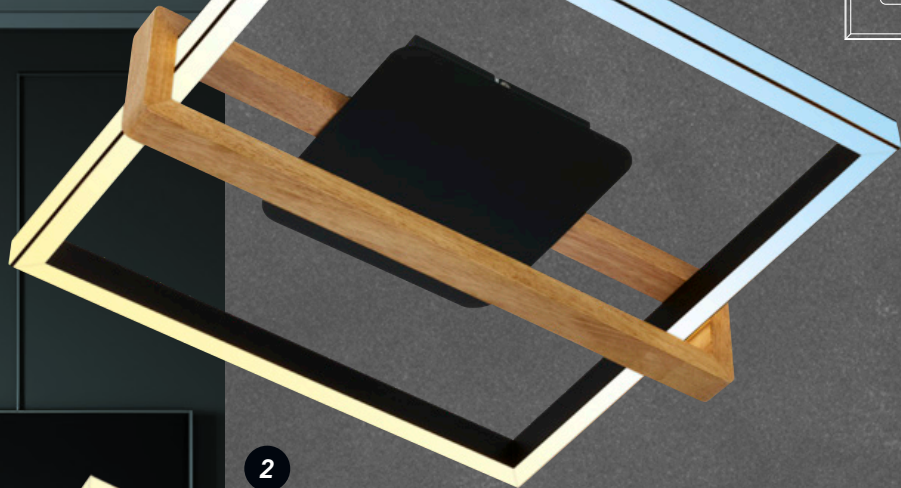
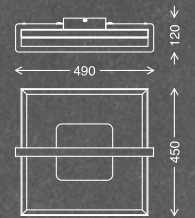

2

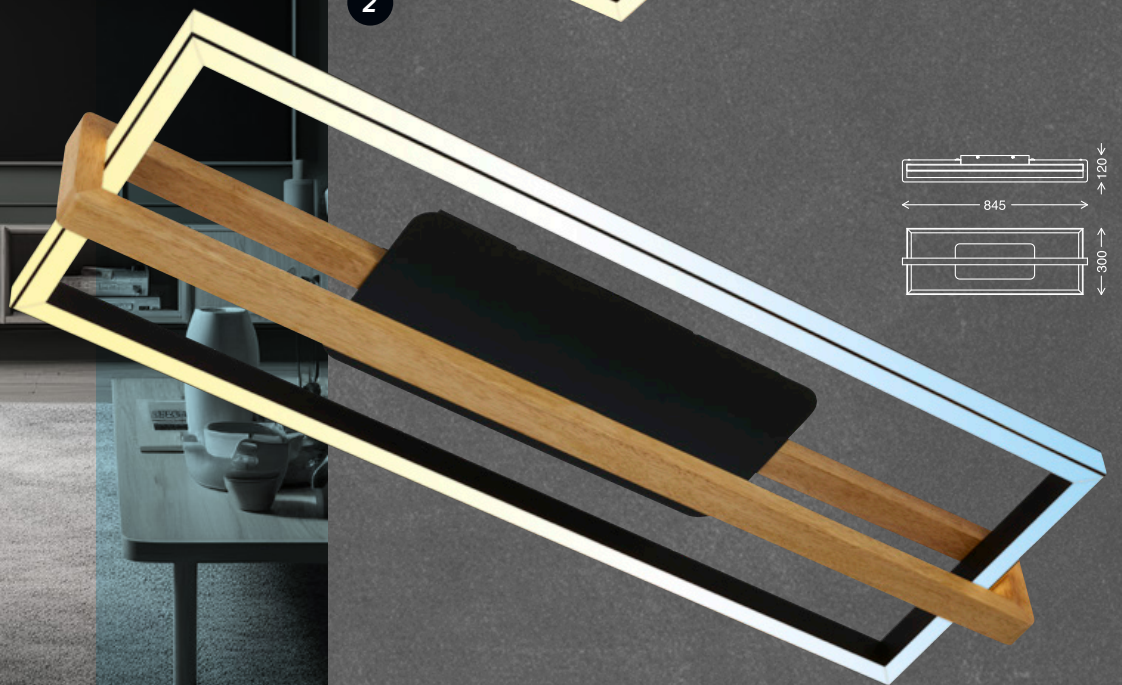
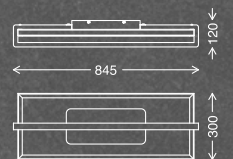

3768015

1

schwarz/black/noir

inkl. LED 34 W 4.000lm
2.700K - 6.500K
4002707446163

3769015

2

schwarz/black/noir

inkl. LED 43 W 5.000lm
2.700K - 6.500K
4002707446224



The mark of responsible forestry

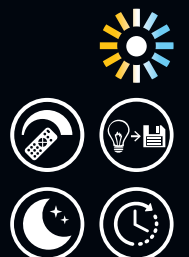

FRAME NESTED

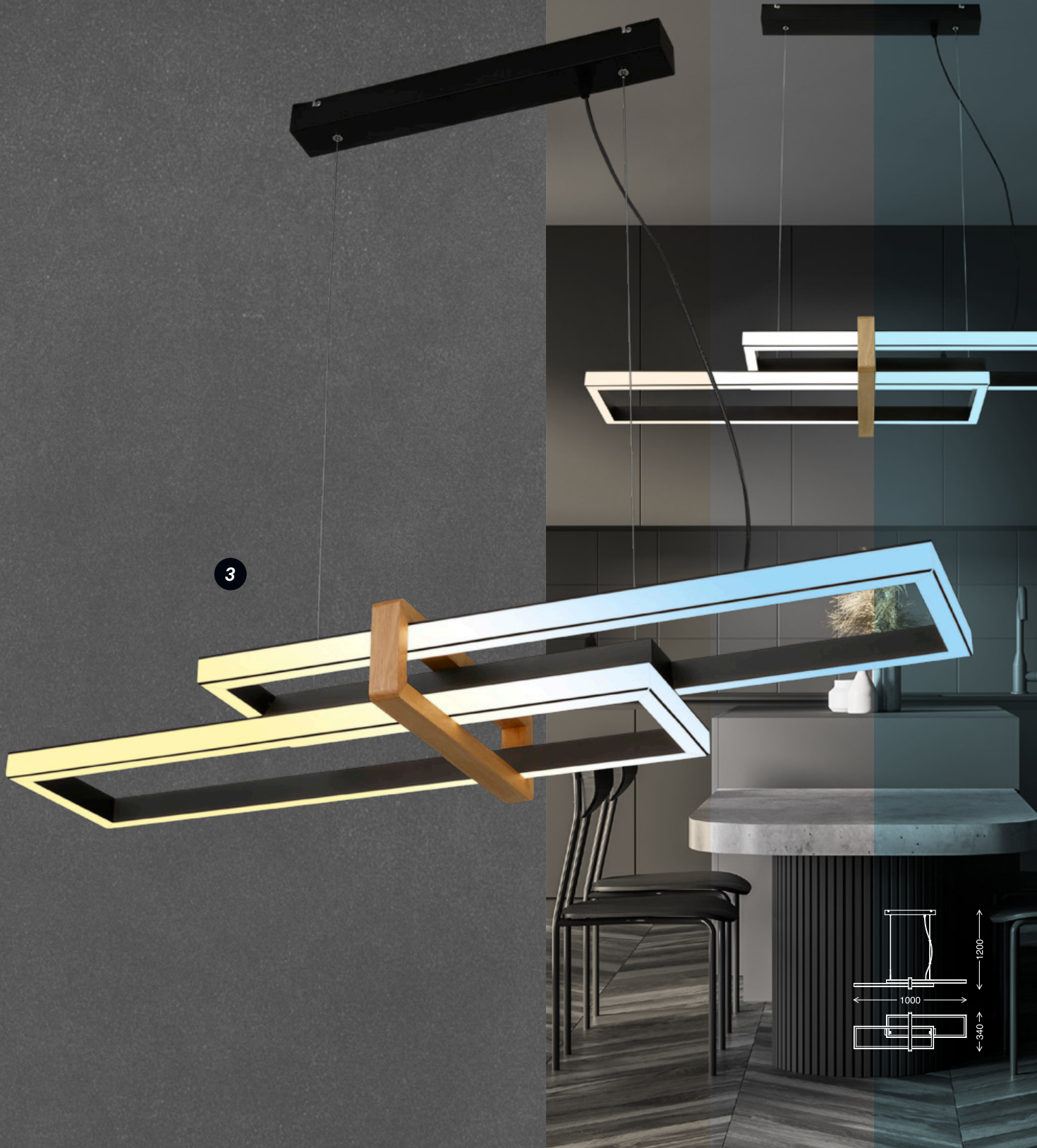

3

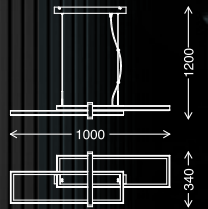

3

4768015

schwarz/black/noir

inkl. LED 39 W 4.400 lm
2.700 K - 6.500 K
4002707446231



The mark of
responsible forestry

MOLDURA

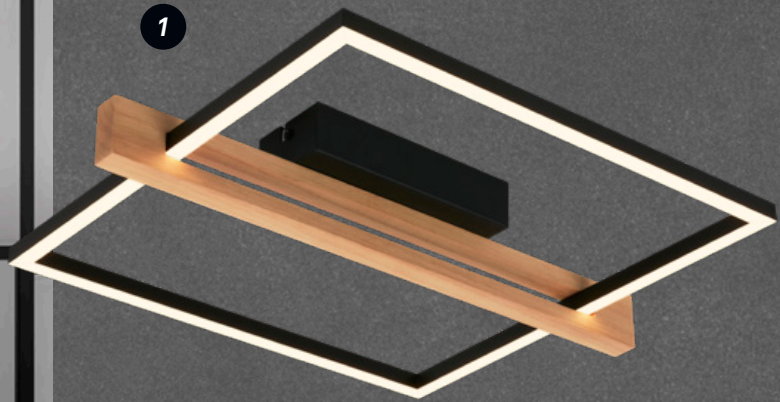

1

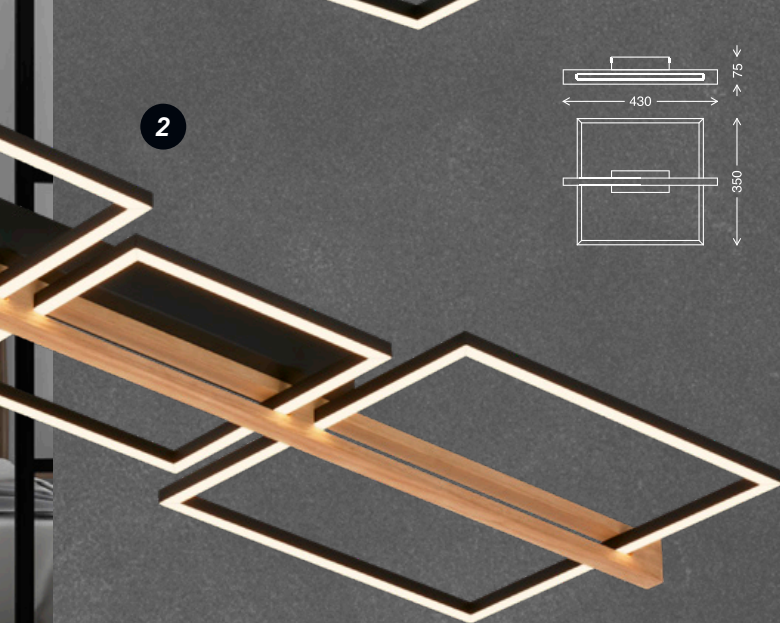

2

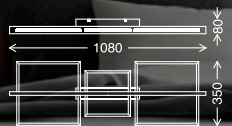
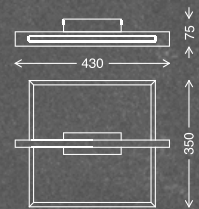

3842014

1

schwarz/black/noir

inkl. LED 14 W 1.650 lm
3.000 K
4002707461975

3843014

2

schwarz/black/noir

inkl. LED 24 W 4.300 lm
3.000 K
4002707461982



The mark of responsible forestry



3

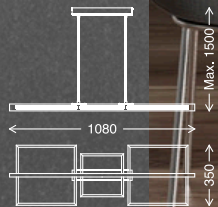

3

4842014

schwarz/black/noir

*inkl. LED 36 W 4.300 lm
3.000 K
4002707461999*



The mark of responsible forestry

BACK
LIGHT
EFFECT

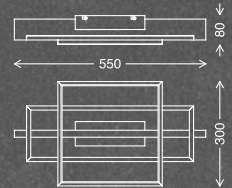

1



2

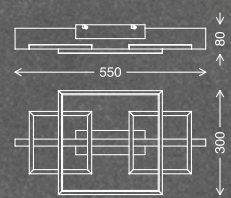
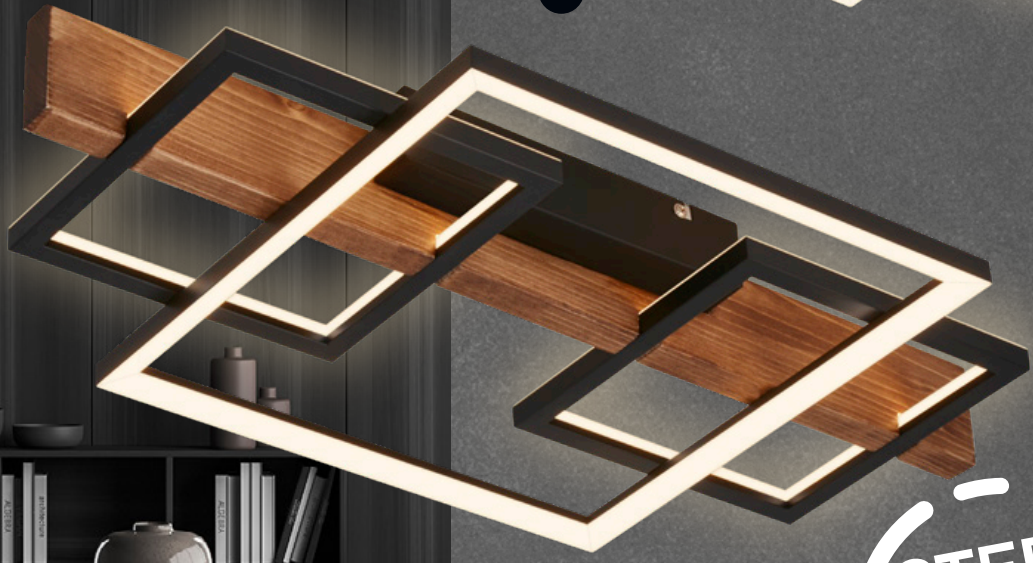

3839014

1

schwarz/black/noir
inkl. LED 32 W 3.200 lm
3.000 K
4002707461807

3840014

2

schwarz/black/noir
inkl. LED 32 W 3.200 lm
3.000 K
4002707461814



The mark of responsible forestry



3

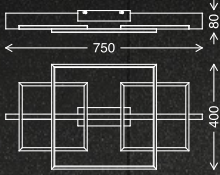

The mark of responsible forestry

3

3841014

schwarz/black/noir

*inkl. LED 36 W 4.300 lm
3.000 K
4002707461852*

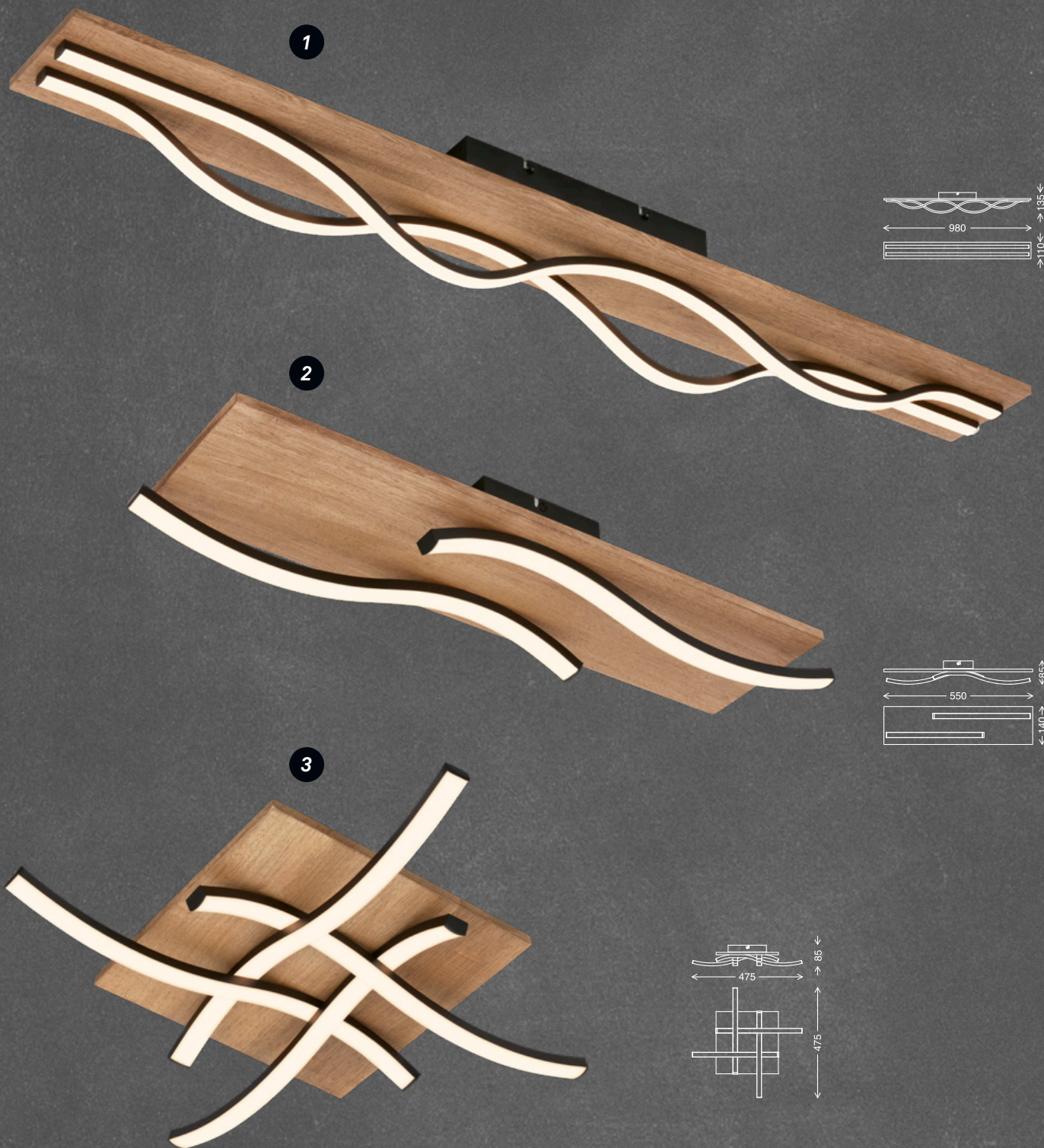

3817014

1

schwarz/black/noir

*inkl. LED 29 W 3.200 lm
3.000 K
4002707461562*

3815014

2

schwarz/black/noir

*inkl. LED 11 W 960 lm
3.000 K
4002707461548*

3816014

3

schwarz/black/noir

*inkl. LED 14 W 1.600 lm
3.000 K
4002707461555*



The mark of responsible forestry

4

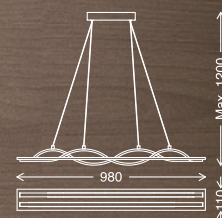

The mark of responsible forestry

4

3818014

schwarz/black/noir

inkl. LED 29 W 3.200 lm
3.000 K
4002707461579

FRAME

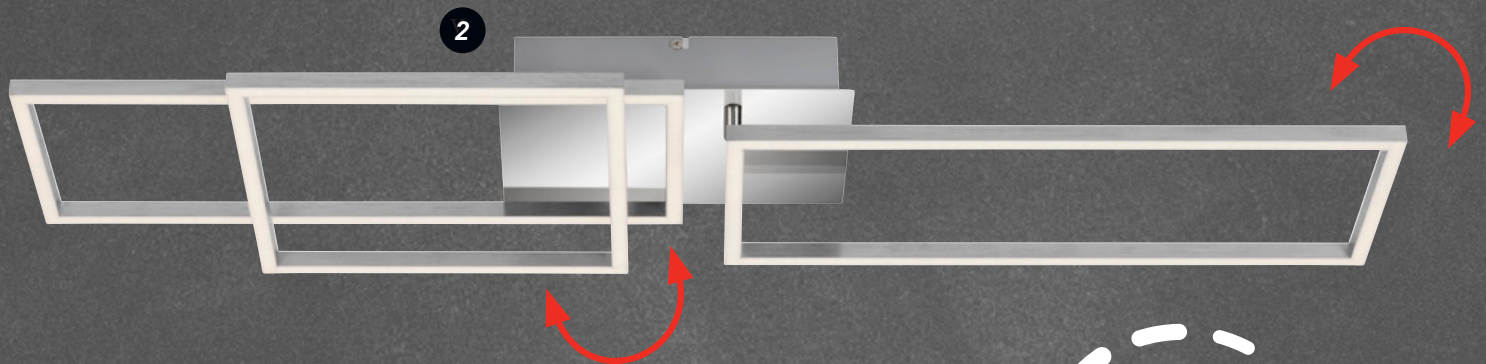
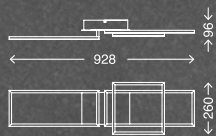
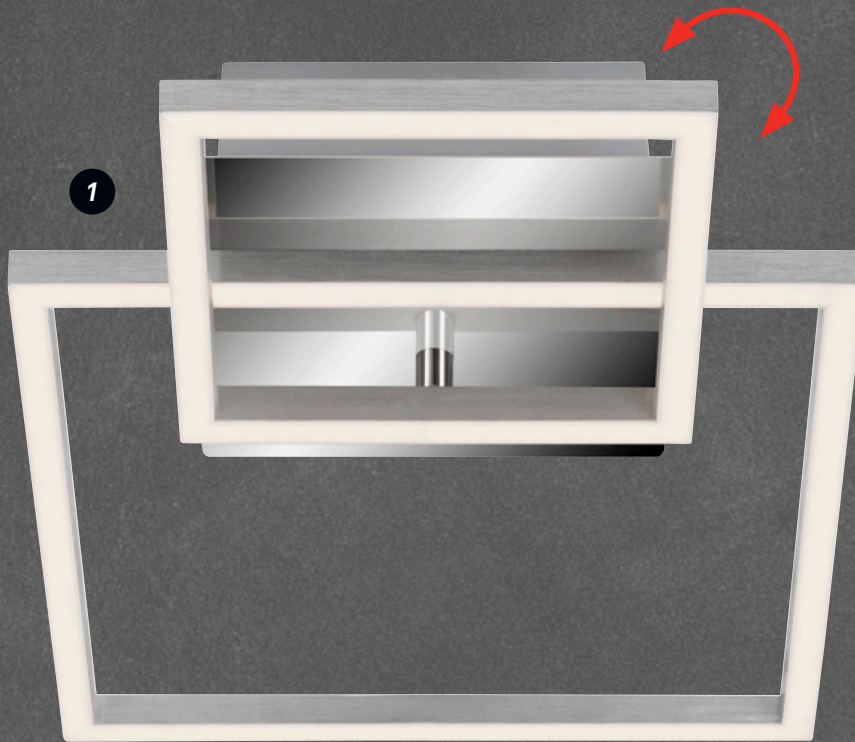
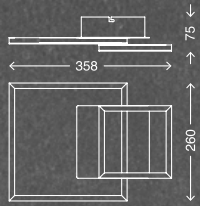

3118-018

1

chrom-alu/chrome-alu/
chrome-alu
inkl. LED Platine 19,5 W 1.850 lm
3.000 K
4002707364559

3136-018

2

chrom-alu/chrome-alu/
chrome-alu
inkl. LED Platine 42 W 3.900 lm
3.000 K
4002707364610



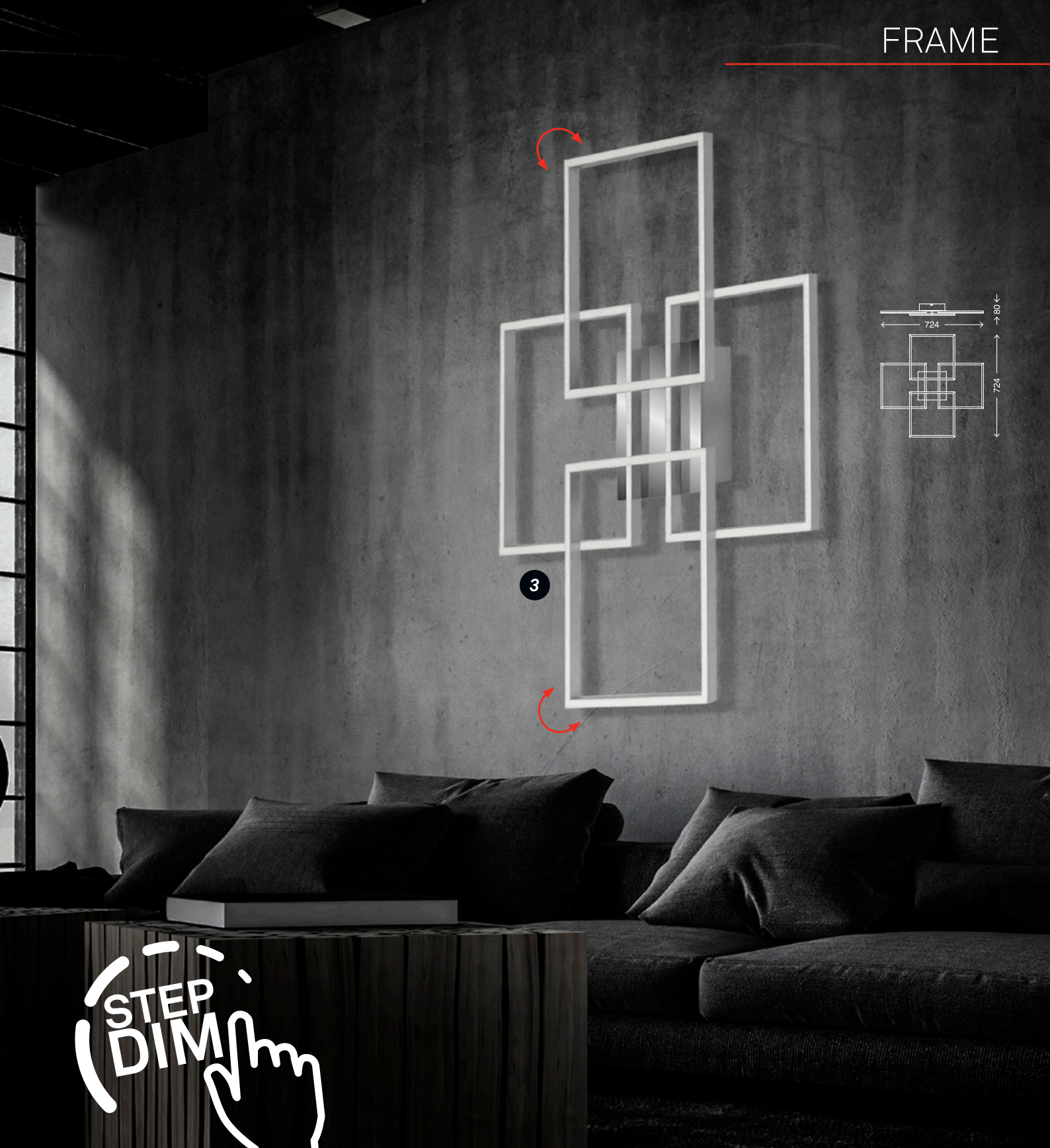

STEP
DIM



3

3131-018

chrom-alu/chrome-alu/
chrome-alu
inkl. LED Platine 48 W 4.400 lm
3.000 K
4002707364580

FRAME

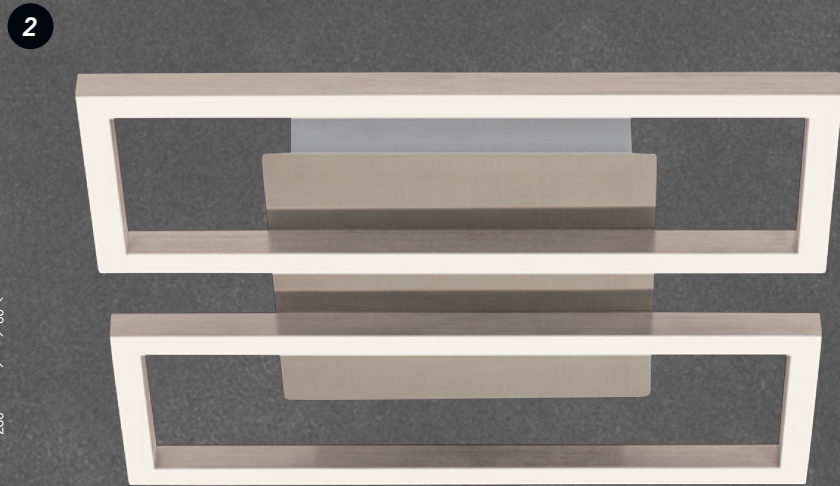
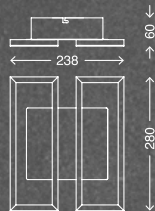
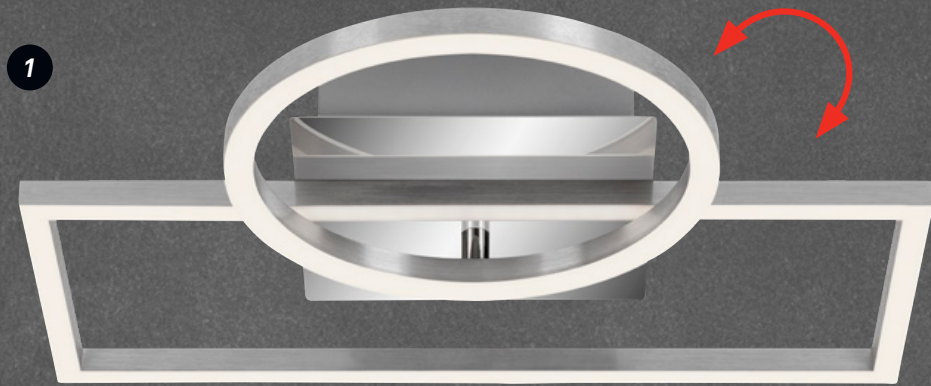
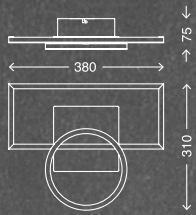

3108-018

1

chrom-alu/chrome-alu/
chrome-alu
inkl. LED Platine 19W 1.550 lm
3.000K
4002707364573

3107-012

2

matt-nickel/satin nickel/
nickel mat
inkl. LED Platine 14W 1.100 lm
3.000K
4002707364566



3

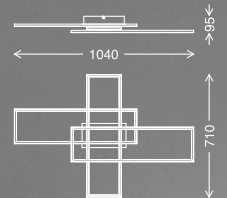
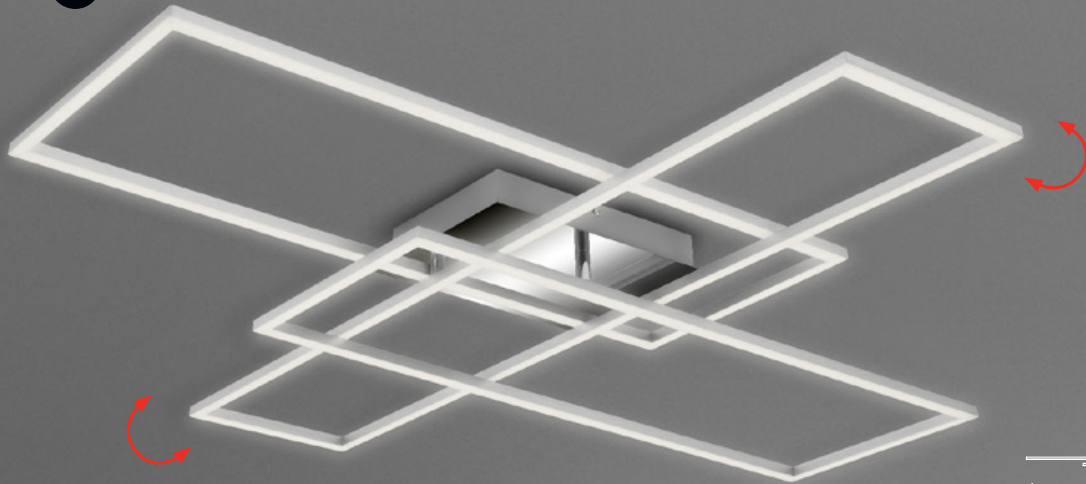

3

3504-018

chrom-alu/chrome-alu/
chrome-alu
inkl. LED Platine 50 W 6.600 lm
3.000 K
4002707409090

FRAME

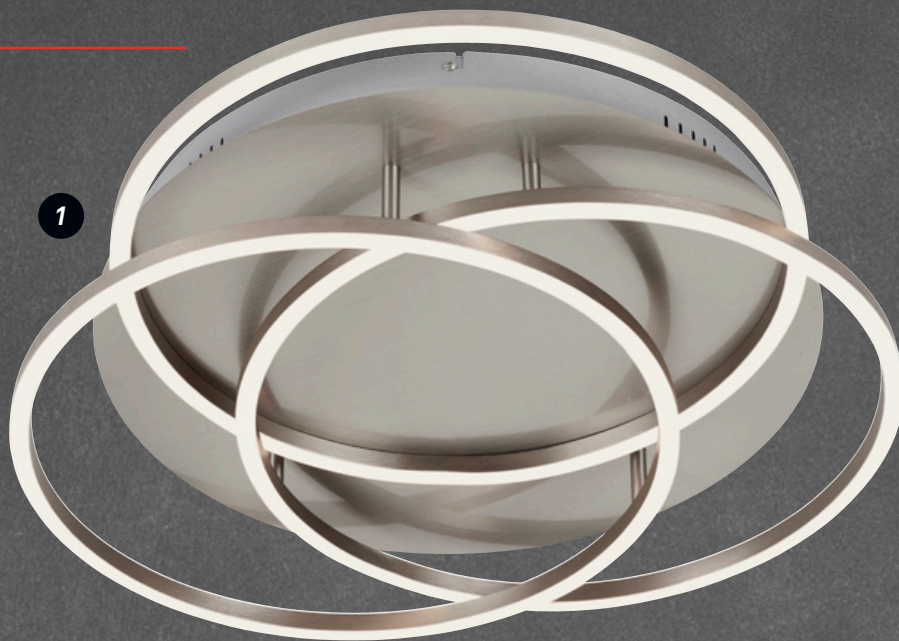

1

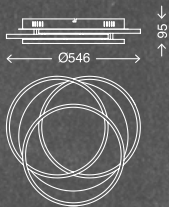

2

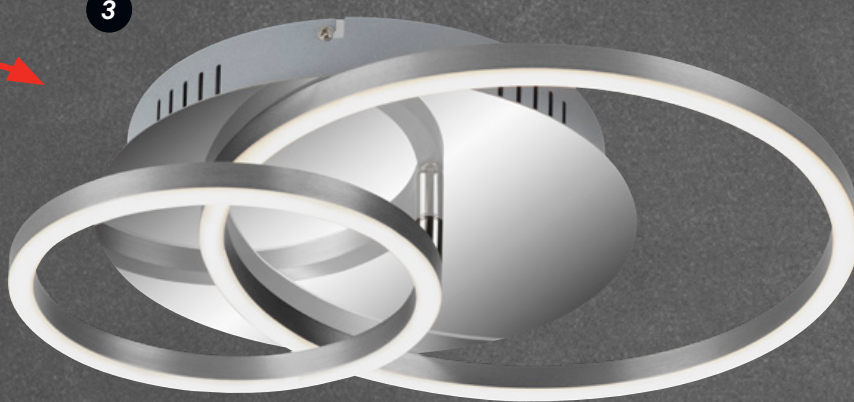
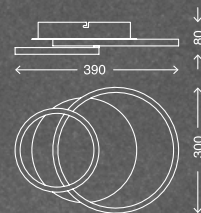

3



3248-012

1

*matt-nickel/satin nickel/
nickel mat
inkl. LED Platine 49,5 W 4.050 lm
3.000 K
4002707359128*

3222-012

2

*matt-nickel/satin nickel/
nickel mat
inkl. LED Platine 24,5 W 2.800 lm
3.000 K
4002707359210*

3222-018

3

*chrom-alu/chrome-alu/
chrome-alu
inkl. LED Platine 24,5 W 2.800 lm
3.000 K
4002707359227*





4

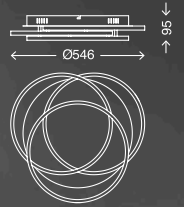

4

3248-018

chrom-alu/chrome-alu/
chrome-alu
inkl. LED Platine 49,5 W 4.050 lm
3.000 K
4002707358756

1

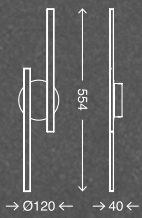
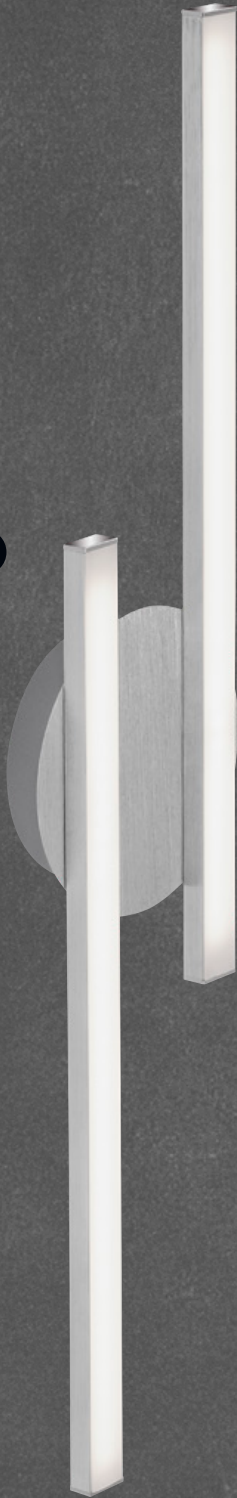

2

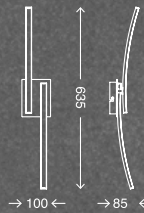

3257-029

1

aluminiumfarbig/aluminium
coloured/couleur aluminium
inkl. LED Platine 12W 1.200 lm
3.000K
4002707342540

3259-029

2

aluminiumfarbig/aluminium
coloured/couleur aluminium
inkl. LED Platine 12W 960 lm
3.000K
4002707342564





3 3165-029

aluminiumfarbig/aluminium
coloured/colour aluminium
inkl. LED 18 W 1.400 lm
3.000 K
4002707366492

4 3258-029

aluminiumfarbig/aluminium
coloured/colour aluminium
inkl. LED Platine 12 W 1.200 lm
3.000 K
4002707342557



LOFT
230



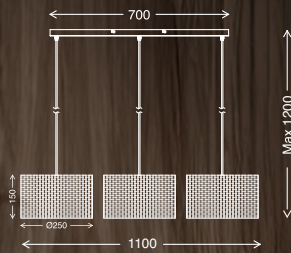

*Nature meets
modern style*

Leuchten aus **SEEGRAS** kombinieren Nachhaltigkeit, Ästhetik und traditionelle Handwerkskunst zu umweltfreundlichen, organisch anmutenden Lichtquellen, die vielseitige Designmöglichkeiten bieten.

Lamps made from seagrass combine sustainability, aesthetics, and traditional craftsmanship into eco-friendly, organically appealing light sources that offer versatile design possibilities.

Les lampes en herbes marines allient durabilité, esthétique et artisanat traditionnel en des sources lumineuses écologiques et organiquement attrayantes, offrant de nombreuses possibilités de design.



4855034

1

holzfarbig/wood coloured/
couleur bois
exkl. 3x E27 max. 10 W

4002707463337



2



2

1855014

holzfarbig/wood coloured/
couleur bois
exkl. 1x E27 max. 10 W

4002707463214

Material

SEEGRAS
SEAGRASS
ALGUES MARINES

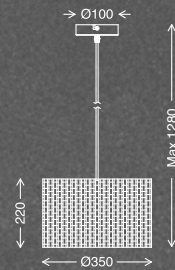

1

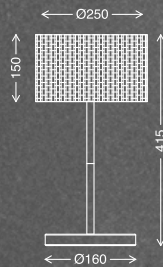

2

7855014

1

holzfarbig/wood coloured/
couleur bois
exkl. 1x E27 max. 10 W

4002707463177

4855014

2

holzfarbig/wood coloured/
couleur bois
exkl. 1x E27 max. 10 W

4002707463313



3

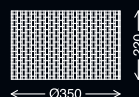

3

3855014

holzfarbig/wood coloured/
couleur bois
exkl. 1x E27 max. 10W

4002707463320



*Nature meets
modern style*

Leuchten aus **STROH** sind ein hervorragendes Beispiel für die kreative Nutzung von Naturmaterialien im modernen Design. Stroh, ein leicht verfügbares und erneuerbares Material, bringt eine rustikale, natürliche Ästhetik in jede Inneneinrichtung.

Straw lamps combine sustainability, natural aesthetics, and craftsmanship by transforming an easily available, renewable material into rustic, cozy light sources. These eco-friendly lamps promote local artisanship and offer diverse design possibilities through various weaving techniques.

Les lampes en paille allient durabilité, esthétique naturelle et savoir-faire artisanal en transformant un matériau facilement disponible et renouvelable en sources lumineuses rustiques et chaleureuses. Ces lampes écologiques favorisent l'artisanat local et offrent de nombreuses possibilités de design grâce à diverses techniques de tissage.

Living Nature



1

1854014

holzfarbig/wood coloured/
couleur bois
exkl. E27 max. 10 W

4002707463207



1

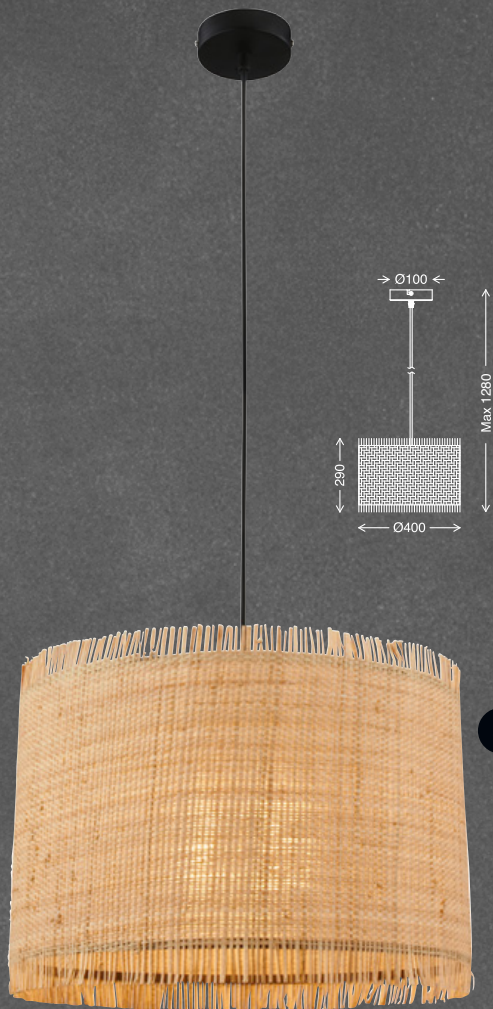
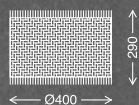

3

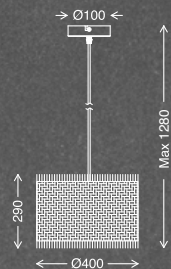

2

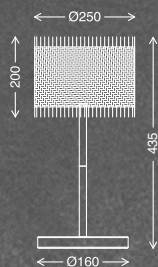

Material

STROH
STRAW
PAILLE

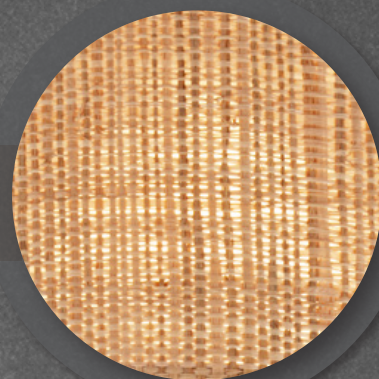

3854014

1

holzfarbig/wood coloured/
couleur bois
exkl. 1x E27 max. 10 W

4002707463290

7854014

2

holzfarbig/wood coloured/
couleur bois
exkl. 1x E27 max. 10 W

4002707463160

4854014

3

holzfarbig/wood coloured/
couleur bois
exkl. 1x E27 max. 10 W

4002707463283

4

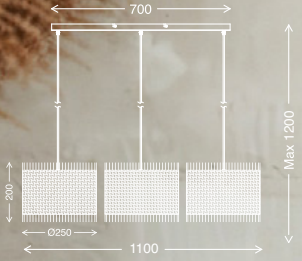

Living Nature



4 **4854034**
holzfarbig/wood coloured/
couleur bois
exkl. 3x E27 max. 10 W
4002707463306



*Nature meets
modern style*

STOFFLEUCHTEN MIT ECHTEM BLÄTTERDEKOR sind einzigartige Kunstwerke, die durch die Integration echter Blätter in den Stoff jede Leuchte zu einem Unikat machen. Sie bringen natürliche Schönheit in den Innenraum und erzeugen ein warmes, diffuses Licht, das eine gemütliche Atmosphäre schafft.

Fabric lights with real leaf decoration are unique works of art that make each light unique by integrating real leaves into the fabric. They bring natural beauty to the interior and create a warm, diffused light that creates a cozy atmosphere.

Les luminaires en tissu avec un véritable décor de feuilles sont des œuvres d'art uniques. L'intégration de véritables feuilles dans le tissu fait de chaque luminaire une pièce unique. Ils apportent une beauté naturelle à l'intérieur et produisent une lumière chaude et diffuse qui crée une atmosphère confortable.



1

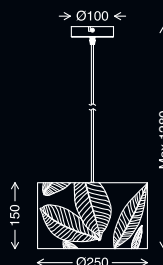

1

4853014

holzfarbig/wood coloured/
couleur bois
exkl. 1x E27 max. 10W

4002707463252

2



Material

STOFF MIT ECHTEM BLÄTTERDEKOR
 FABRIC WITH REAL LEAF DECORATION
 TISSU AVEC VÉRITABLE DÉCOR DE FEUILLES

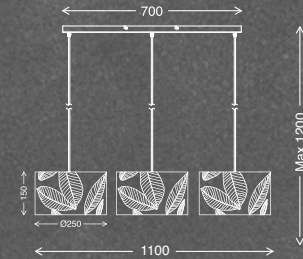

1

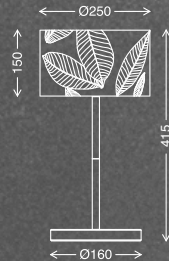

3



7853014

1

holzfarbig/wood coloured/
 couleur bois
 exkl. 1x E27 max. 10 W

4002707463146

4853034

2

holzfarbig/wood coloured/
 couleur bois
 exkl. 3x E27 max. 10 W

4002707463276

3853014

3

holzfarbig/wood coloured/
 couleur bois
 exkl. 1x E27 max. 10 W

4002707463269

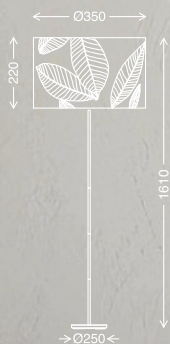

4



4

1853014

holzfarbig/wood coloured/
couleur bois
exkl. 1x E27 max. 10 W

4002707463191



1

4851034

1

holzfarbig/wood coloured/
couleur bois
exkl. 3x E27 max. 10 W

4002707463245

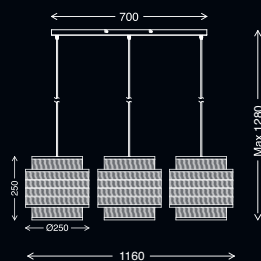



Nature meets modern style

Diese Leuchten bestehen durch ihre Leichtigkeit und Vielseitigkeit, da das **BAST** mit verschiedenen Flechttechniken zu vielfältigen Formen und Mustern verarbeitet werden kann.

These lamps stand out for their lightness and versatility, as the bast can be crafted into various shapes and patterns using different weaving techniques.

Ces lampes se distinguent par leur légèreté et leur polyvalence, car la bast peut être transformée en différentes formes et motifs grâce à diverses techniques de tissage.





1

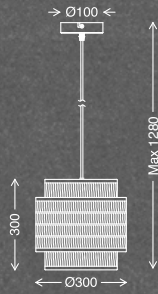

3

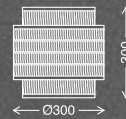

2

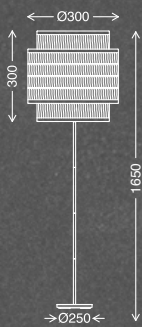

Material

BAST
BAST
BAST

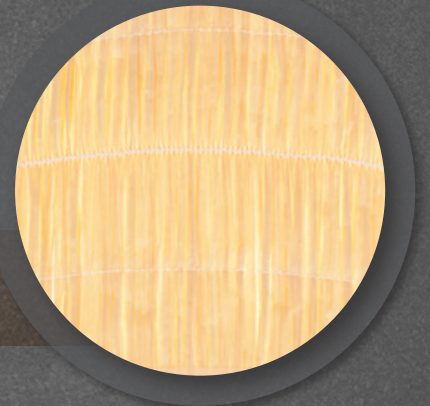

1851014

1

holzfarbig/wood coloured/
couleur bois
exkl. 1x E27 max. 10 W

4002707463184

4851014

2

holzfarbig/wood coloured/
couleur bois
exkl. 1x E27 max. 10 W

4002707463221

3851014

3

holzfarbig/wood coloured/
couleur bois
exkl. 1x E27 max. 10 W

4002707463238



4

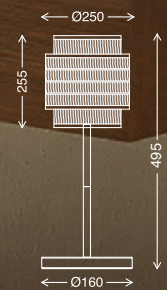

4

7851014

holzfarbig/wood coloured/
couleur bois
exkl. 1x E27 max. 10 W

4002707463139



1



4759011

1

holzfarbig/wood coloured/
couleur bois
exkl. 1x E27 max. 10 W

4002707445579



The mark of
responsible forestry



2

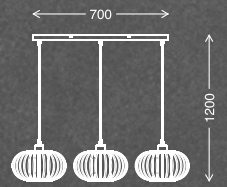

2

4759031

holzfarbig/wood coloured/
couleur bois
exkl. 3x E27 max. 10 W

4002707445562

1



1759011

1

holzfarbig/wood coloured/
couleur bois
exkl. 1x E27 max. 10 W

4002707445555



The mark of
responsible forestry

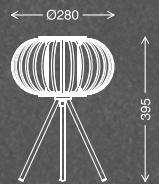
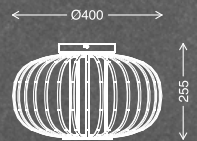

2

3759011

holzfarbig/wood coloured/
couleur bois
exkl. 1x E27 max. 10 W

4002707445586

3

7759011

holzfarbig/wood coloured/
couleur bois
exkl. 1x E27 max. 10 W

4002707445548



The mark of
responsible forestry



1486025

1

schwarz/black/noir

exkl. 2x E27 max. 10W

4002707445678

4486035

2

schwarz/black/noir

exkl. 3x E27 max. 10W

4002707445654



The mark of responsible forestry

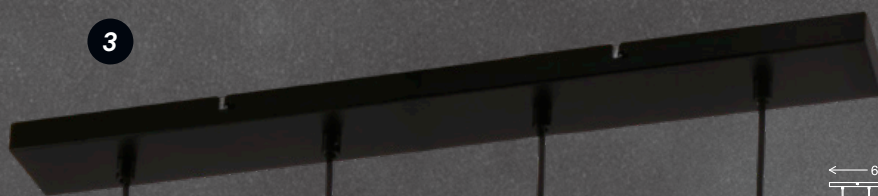

3



4

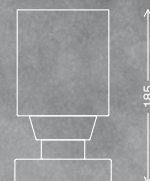

The mark of responsible forestry



3

4486045

schwarz/black/noir
exkl. 4x E27 max. 10W
4002707445661

4

7486015

schwarz/black/noir
exkl. 1x E27 max. 10W
4002707445647



The mark of responsible forestry

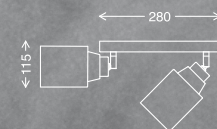
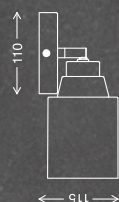

1 **2486015**
 schwarz/black/noir
 exkl. 1x E27 max. 10 W
 4002707445616

2 **2486025**
 schwarz/black/noir
 exkl. 2x E27 max. 10 W
 4002707445623

3 **2486035**
 schwarz/black/noir
 exkl. 3x E27 max. 10 W
 4002707445630



The mark of responsible forestry

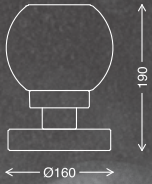
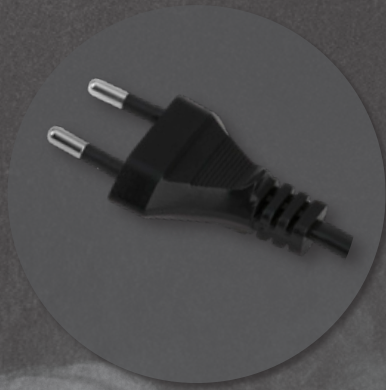

2



1

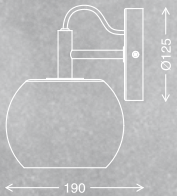

2143014

1

schwarz/black/noir
exkl. 1x E14 max. 10W
4002707445494

7487015

2

schwarz/black/noir
exkl. 1x E14 max. 10W
4002707445685



The mark of responsible forestry

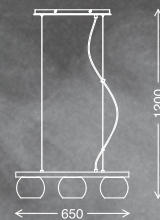

3

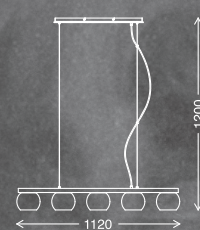

4

3

4143034

schwarz/black/noir
exkl. 3x E14 max. 10W
4002707445470

4

4143054

schwarz/black/noir
exkl. 5x E14 max. 10W
4002707445487



The mark of responsible forestry

1

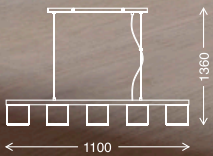

4075-054

1

grau/grey/gris

exkl. 5x E14 / max. 25 W
ohne Leuchtmittel/without bulb/
sans ampoule

4002707385042





2

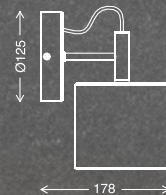
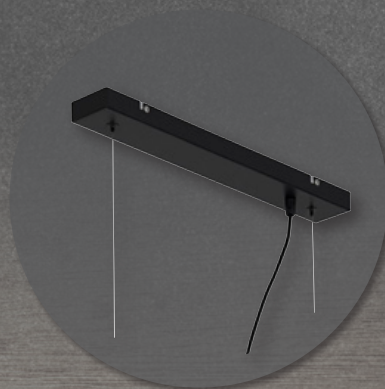

3

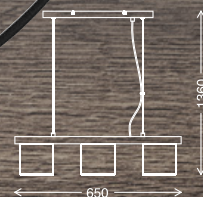

2

2075-014

grau/grey/gris

exkl. 1x E14 / max. 25W
ohne Leuchtmittel/without bulb/
sans ampoule

4002707385059

3

4075-034

grau/grey/gris

exkl. 3x E14 / max. 25W
ohne Leuchtmittel/without bulb/
sans ampoule

4002707385035

BARNIM

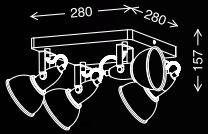

2901-045

1

schwarz/black/noir

exkl. 4x E14 / max. 25 W
ohne Leuchtmittel/without bulb/
sans ampoule

4002707385158



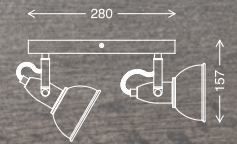
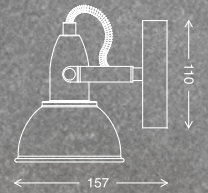

2 **2901-015**

schwarz/black/noir

*exkl. 1x E14 / max. 25W
ohne Leuchtmittel/without bulb/
sans ampoule*

4002707385127

3 **2901-025**

schwarz/black/noir

*exkl. 2x E14 / max. 25W
ohne Leuchtmittel/without bulb/
sans ampoule*

4002707385134

4 **2901-035**

schwarz/black/noir

*exkl. 3x E14 / max. 25W
ohne Leuchtmittel/without bulb/
sans ampoule*

4002707385141

1



2920-045

1

schwarz/black/noir

exkl. 4x GU10 max. 35W
ohne Leuchtmittel/without bulb/
sans ampoule

4002707385691



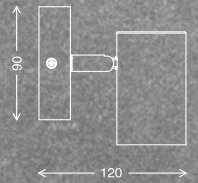
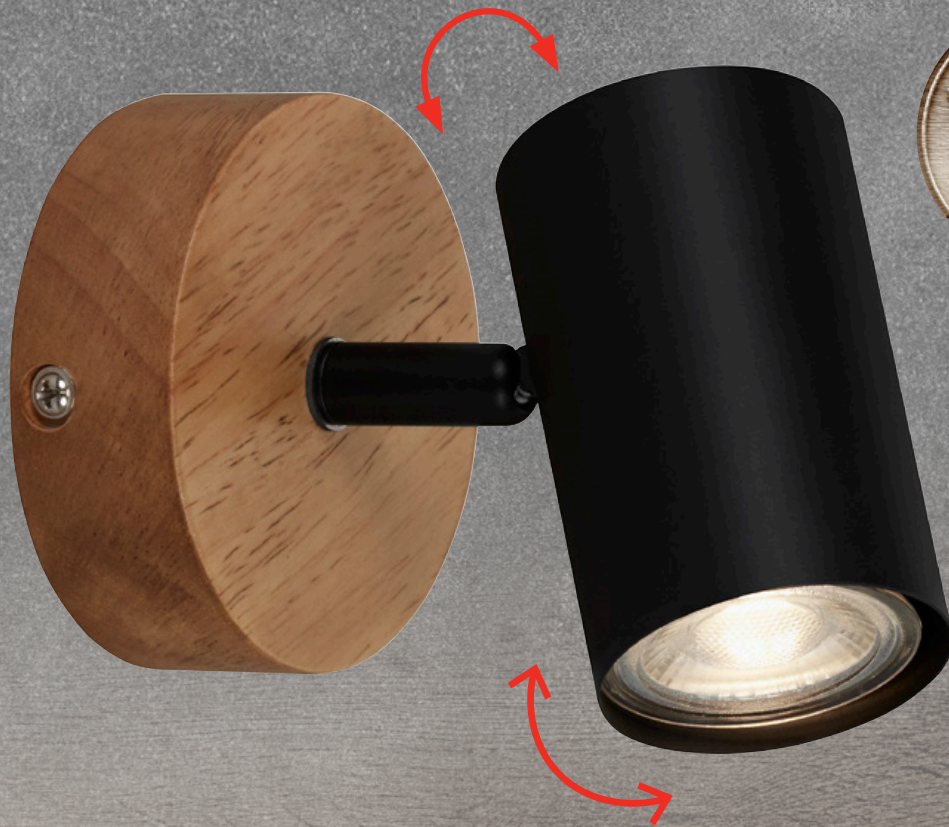

2 **2920-015**

schwarz/black/noir

*exkl. 1x GU10 max. 35W
ohne Leuchtmittel/without bulb/
sans ampoule*

4002707385660

3 **2920-035**

schwarz/black/noir

*exkl. 3x GU10 max. 35W
ohne Leuchtmittel/without bulb/
sans ampoule*

4002707386889

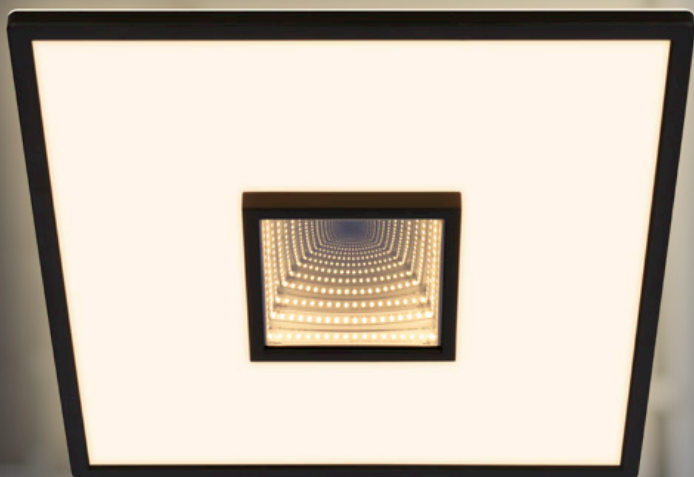

248

DECKENLEUCHTEN

CEILING LIGHTS
PLAFONNIERS





**BACK
LIGHT
EFFECT**

1

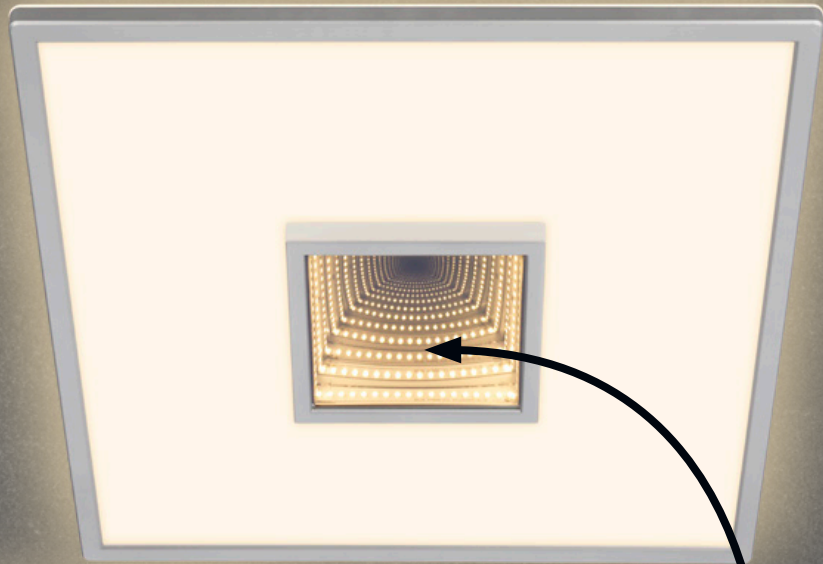

2

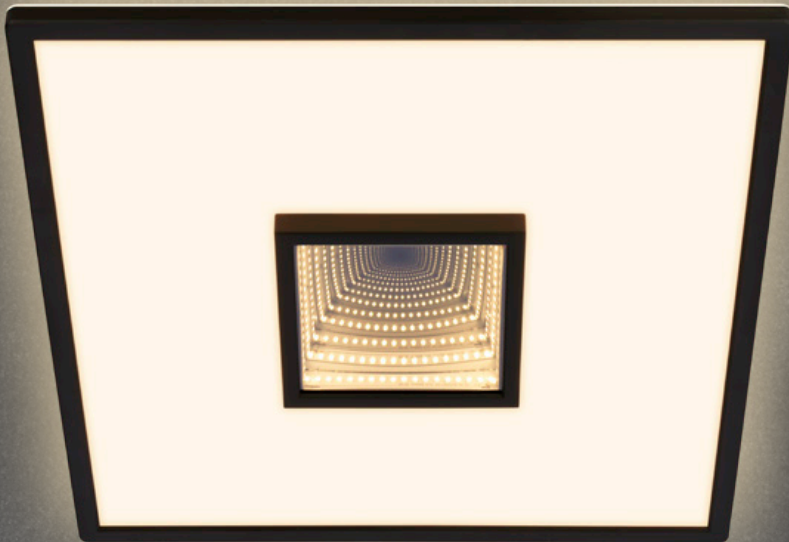

GETRENNT SCHALTBAR
SEPARATELY SWITCHABLE
COMMUTABLE SÉPARÉMENT

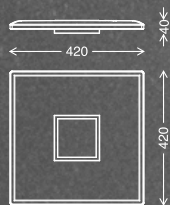

3848014

1

chrom-matt/chrome satin/
chrome mat
inkl. LED Platine 23,5 W 3.500 lm
3.000 K
4002707462088

3848015

2

schwarz/black/noir
inkl. LED Platine 23,5 W 3.500 lm
3.000 K
4002707462071



**BACK
LIGHT
EFFECT**



3

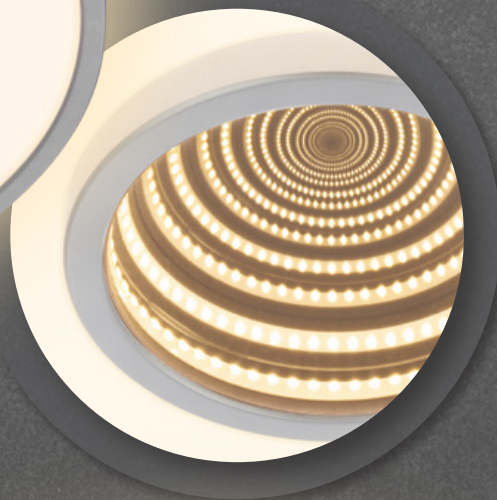

GETRENNT SCHALTBAR
SEPARATELY SWITCHABLE
COMMUTABLE SÉPARÉMENT



4

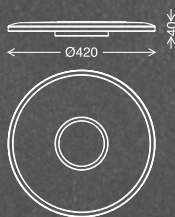

3

3847014

chrom-matt/chrome satin/
chrome mat
inkl. LED Platine 23,5 W 3.500 lm
3.500 K
4002707462064

4

3847015

schwarz/black/noir
inkl. LED Platine 23,5 W 3.500 lm
3.000 K
4002707462057

**BACK
LIGHT
EFFECT**

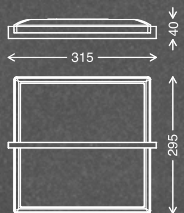
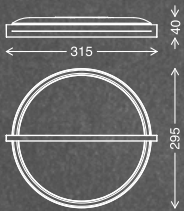

3844015

1

schwarz/black/noir

*inkl. LED Platine 18 W 2.400 lm
3.000 K
4002707462002*

3845015

2

schwarz/black/noir

*inkl. LED Platine 18 W 2.400 lm
3.000 K
4002707462019*



BACK
LIGHT
EFFECT



3

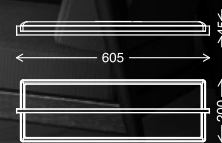

3

3846015

schwarz/black/noir

inkl. LED Platine 22 W 3.000 lm
3.000 K
4002707462026

FREE

BACK
LIGHT
EFFECT

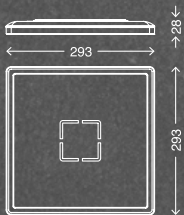
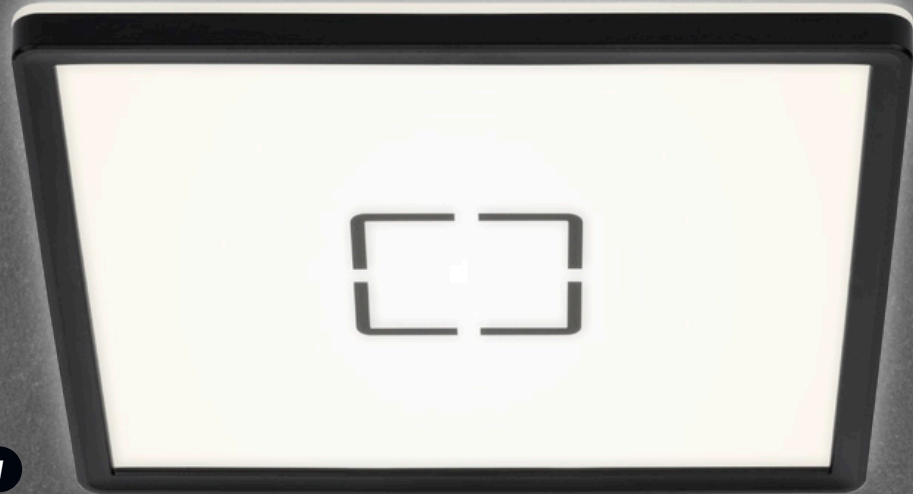

3390-015

1

schwarz/black/noir

*inkl. LED Platine 18W 2.400lm
4.000K
4002707366140*

3390-014

2

*silberfarbig/silver coloured/
couleur argentée
inkl. LED Platine 18W 2.400lm
4.000K
4002707366133*



FREE

BACK
LIGHT
EFFECT

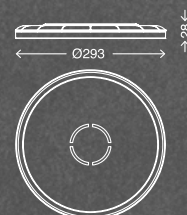
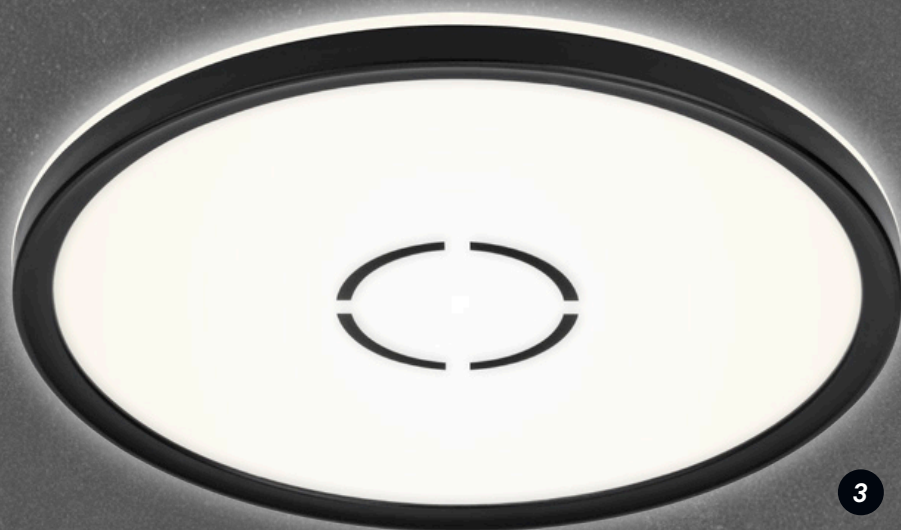

3

3391-015

schwarz/black/noir
inkl. LED Platine 18W 2.400lm
4.000K
4002707366188

4

3391-014

*silberfarbig/silver coloured/
couleur argentée*
inkl. LED Platine 18W 2.400lm
4.000K
4002707366171



FIRE







1



2

7122-414

1

chrom-matt/chrome satin/
chrome mat
inkl. LED Platine 11 W 1.050 lm
4.000 K
4002707361572

7122-416

2

weiß/white/blanc
inkl. LED Platine 11 W 1.050 lm
4.000 K
4002707361589





3

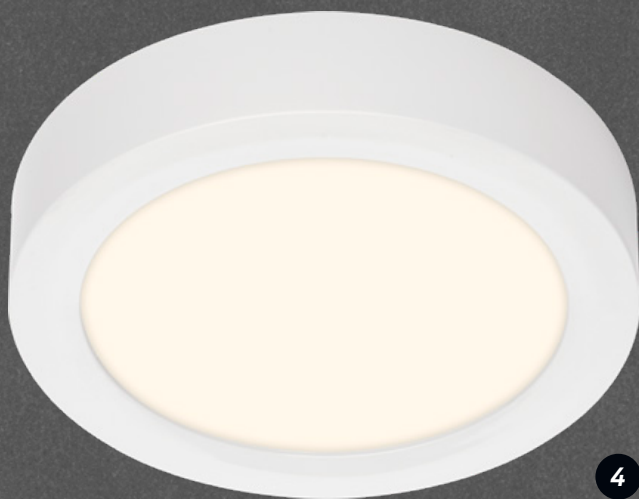

4



3

7122-014

chrom-matt/chrome satin/
chrome mat
inkl. LED Platine 11 W 1.050 lm
3.000 K
4002707361343

4

7122-016

weiß/white/blanc
inkl. LED Platine 11 W 1.050 lm
3.000 K
4002707361350

FIRE/BLACK

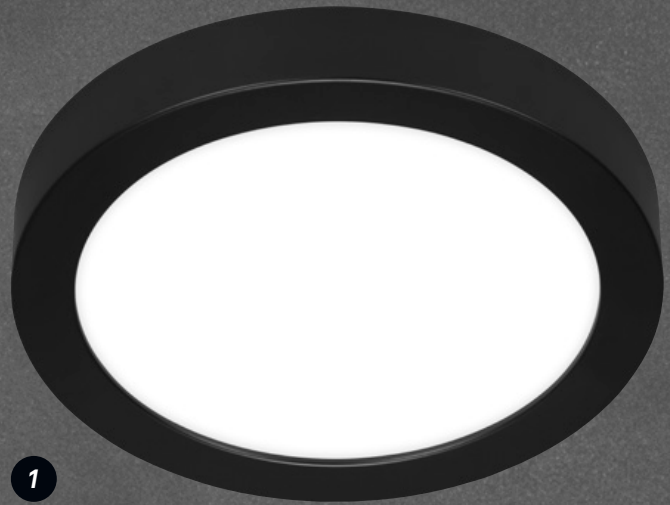
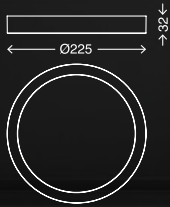

3465-415

1

schwarz/black/noir

*inkl. LED Platine 16,5 W 1.600lm
4.000K
4002707387886*

7117-414

2

*chrom-matt/chrome satin/
chrome mat*

*inkl. LED Platine 16 W 1.600lm
4.000K
4002707361596*



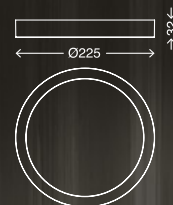

3



3

7117-014

chrom-matt/chrome satin/
chrome mat
inkl. LED Platine 16,5 W 1.600 lm
3.000 K
4002707361138

FIRE

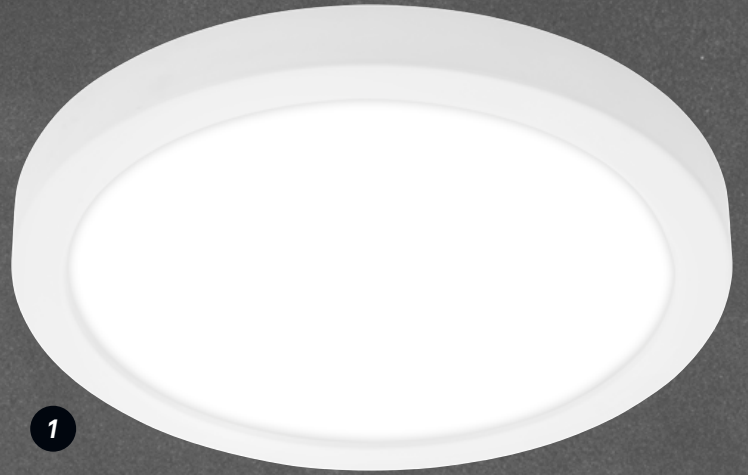
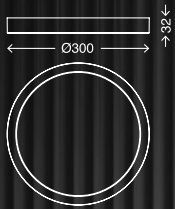

1



2

7141-416

1

weiß/white/blanc

inkl. LED Platine 2,41W 2.200lm

4.000K

4002707361664

7141-414

2

*chrom-matt/chrome satin/
chrome mat*

inkl. LED Platine 21,4W 2.200lm

4.000K

4002707361657



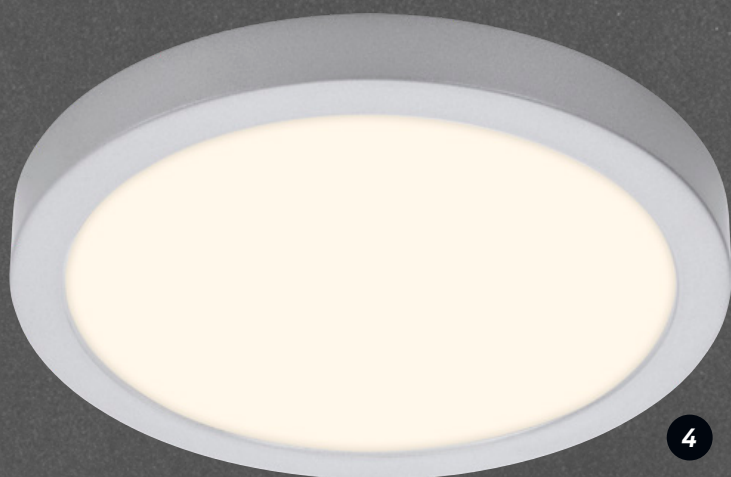
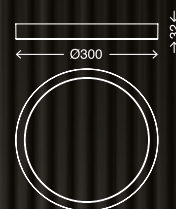
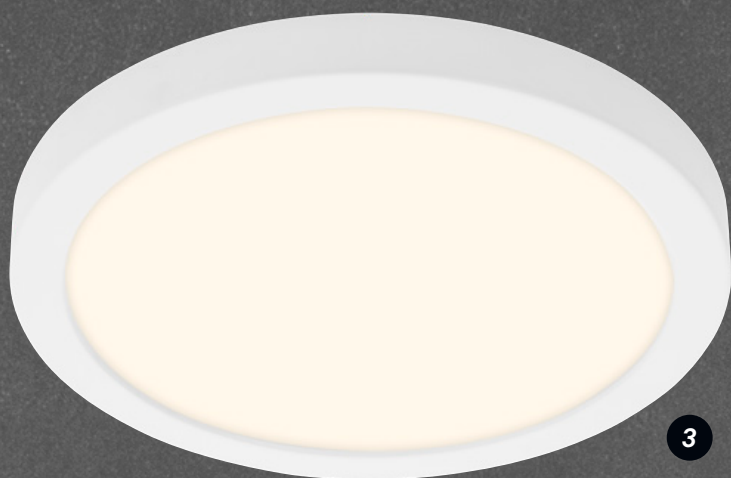

3 **7141-016**
 weiß/white/blanc
 inkl. LED Platine 21,4W 2.200lm
 3.000K
 4002707361640

4 **7141-014**
 chrom-matt/chrome satin/
 chrome mat
 inkl. LED Platine 21,4W 2.200lm
 3.000K
 4002707361633

FIRE DRIP

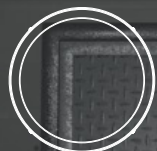
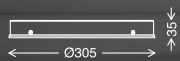

1

7132-414

1

chrom-matt/chrome satin/
chrome mat
inkl. LED Platine 21,4 W 2.200 lm
4.000K
4002707362562



IP44

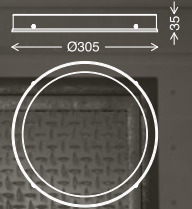
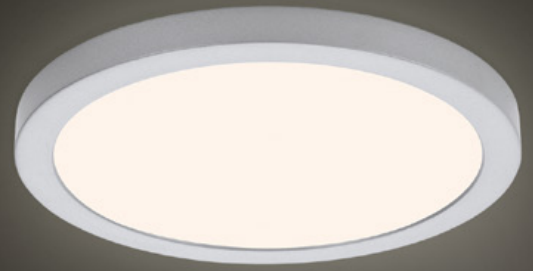

2



2

7132-014

chrom-matt/chrome satin/
chrome mat
inkl. LED Platine 21,4 W 2.200 lm
3.000K
4002707362555

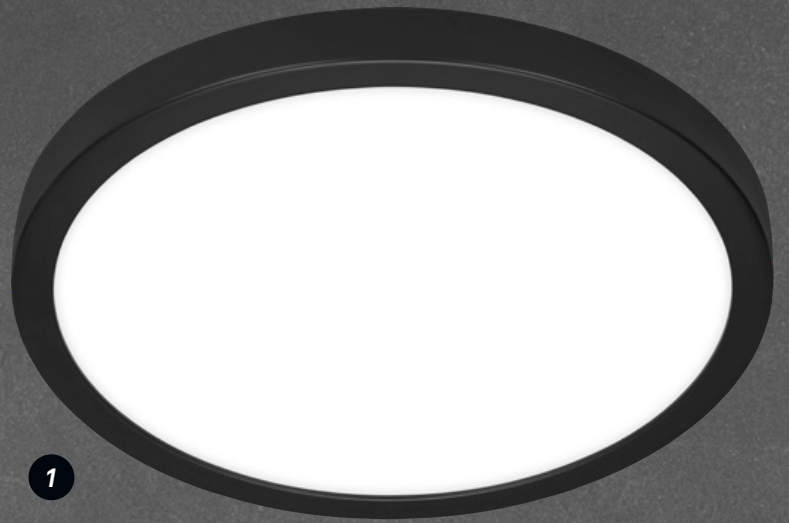
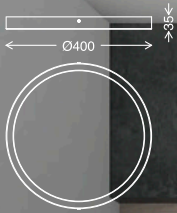

3468-415

1

schwarz/black/noir

*inkl. LED Platine 24,5 W 2.600lm
4.000K
4002707387916*

7143-414

2

*chrom-matt/chrome satin/
chrome mat*

*inkl. LED Platine 24 W 2.600lm
4.000K
4002707361725*



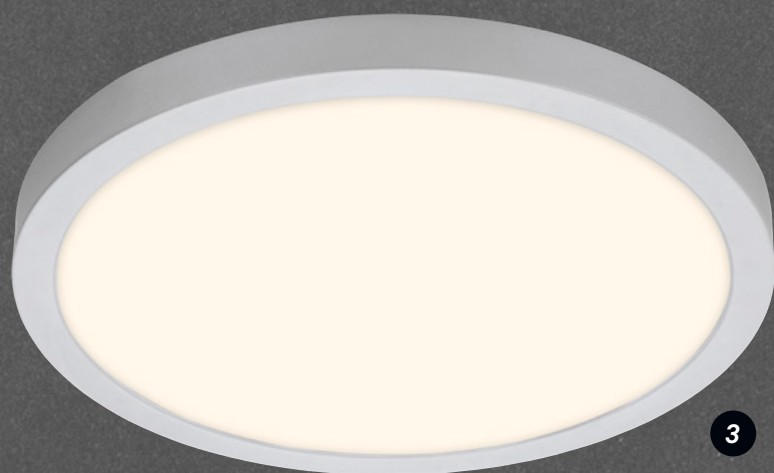

3



3

7143-014

chrom-matt/chrome satin/
chrome mat
inkl. LED Platine 24 W 2.600lm
3.000K
4002707361718

FIRE/BLACK

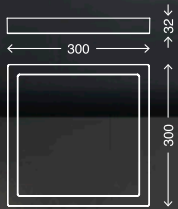
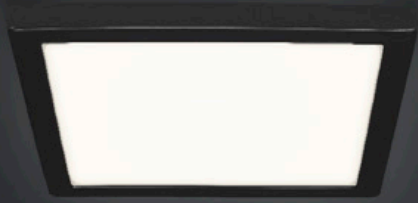

1

2



3467-415

1

schwarz/black/noir

*inkl. LED Platine 20W 2.100lm
4.000K
4002707387909*

7142-414

2

*chrom-matt/chrome satin/
chrome mat*

*inkl. LED Platine 21W 2.150lm
4.000K
4002707361695*



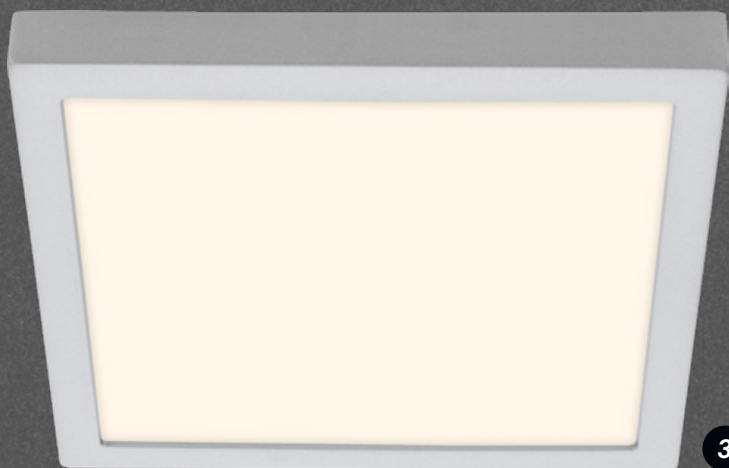

3

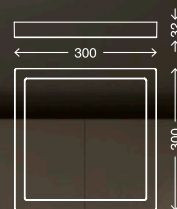
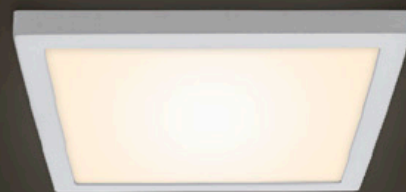

3

7142-014

chrom-matt/chrome satin/
chrome mat
inkl. LED Platine 21W 2.200lm
3.000K
4002707361671

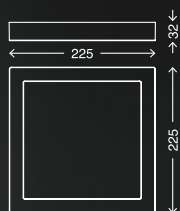
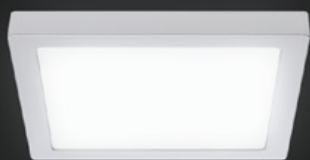

3466-415

1

schwarz/black/noir

*inkl. LED Platine 16 W 1.700 lm
4.000K
4002707387893*

7118-414

2

*chrom-matt/chrome satin/
chrome mat*

*inkl. LED Platine 16 W 1.700 lm
4.000K
4002707361619*



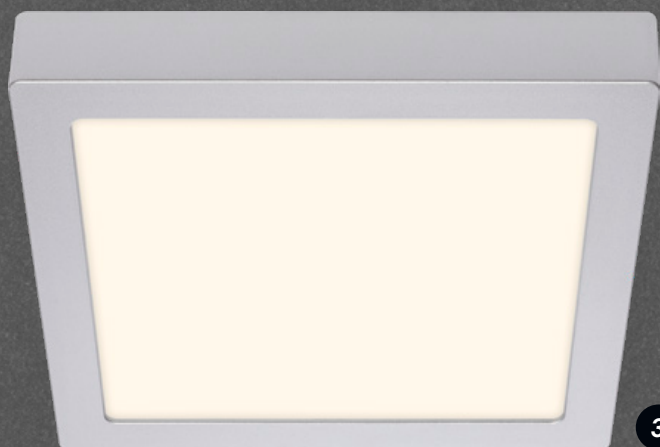

3

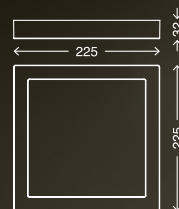
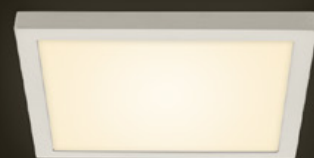

3

7118-014

chrom-matt/chrome satin/
chrome mat
inkl. LED Platine 16 W 1.600 lm
3.000K
4002707361152



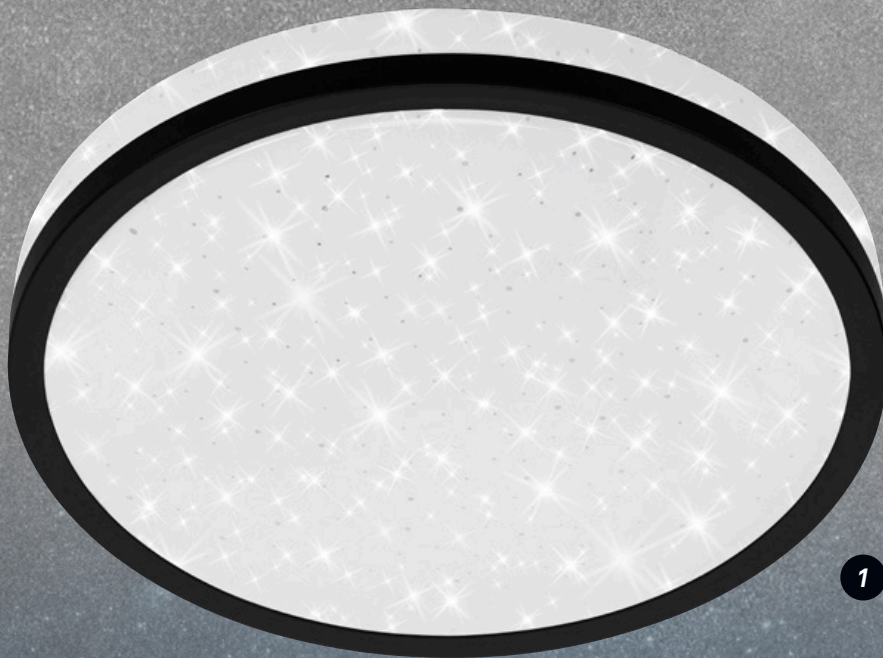

1

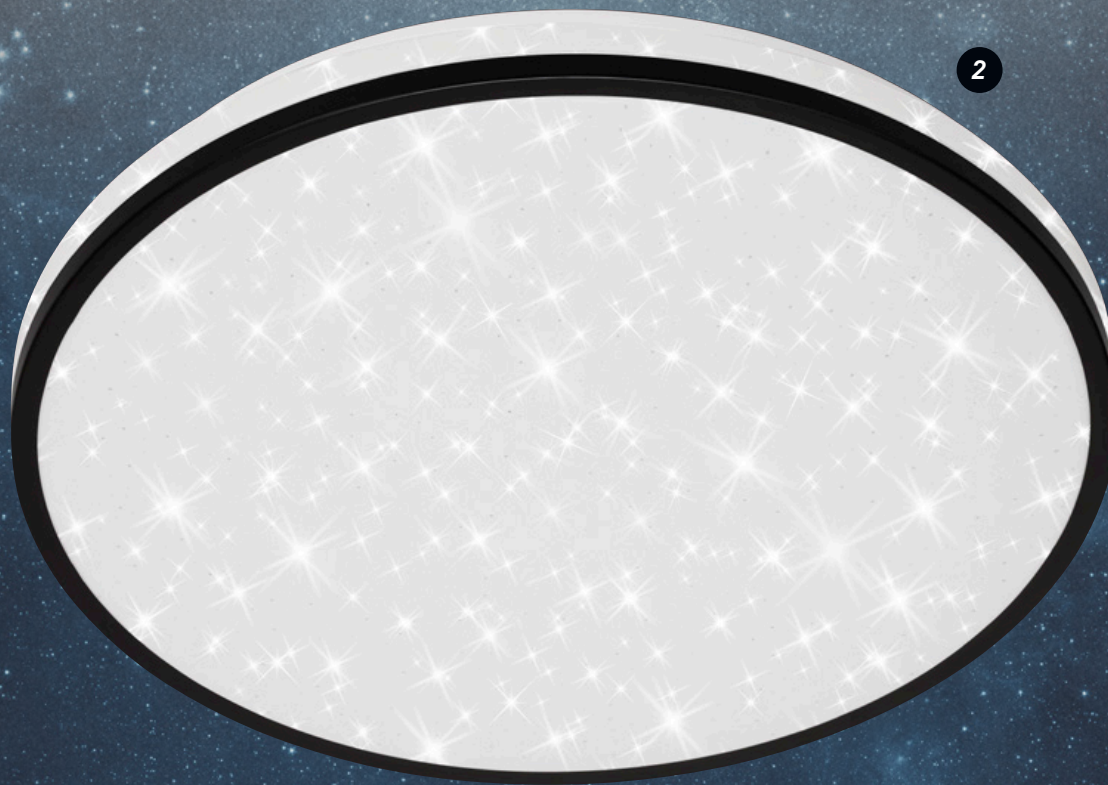
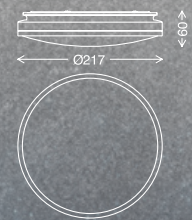

2



1 **3456-015**

schwarz/black/noir

*inkl. LED Platine 10W 1.100lm
4.000K
4002707387251*

2 **3456-215**

schwarz/black/noir

*inkl. LED Platine 24W 2.650lm
4.000K
4002707387282*



SPOTS 290



Alle Spots sind dreh- und schwenkbar.
All spots can be rotated and swiveled.
Tous les spots peuvent être tournés et pivotés.

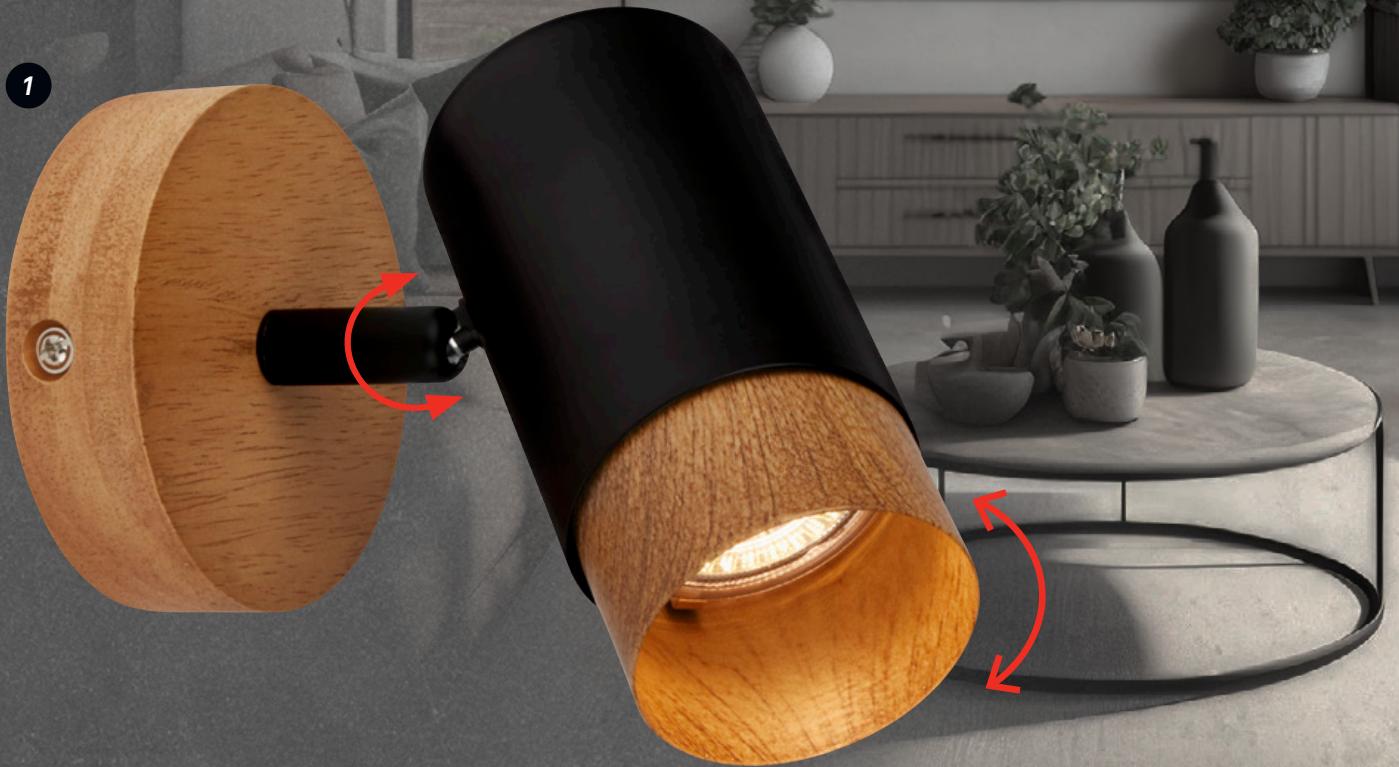
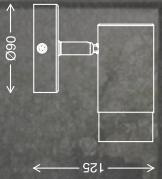

2144015

1

schwarz/black/noir

exkl. 1x LED GU10 max. 9W

4002707445401



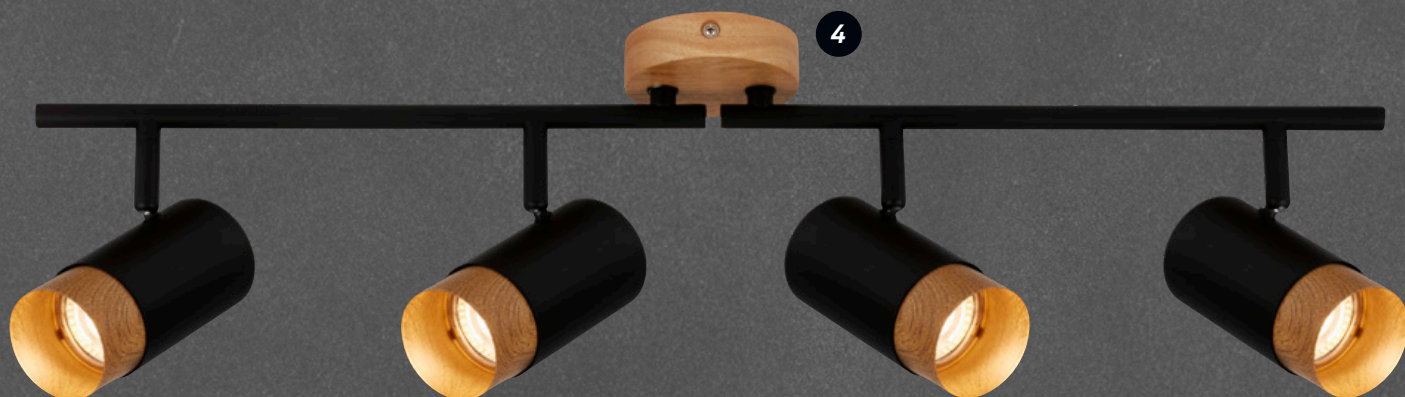
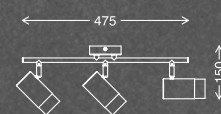
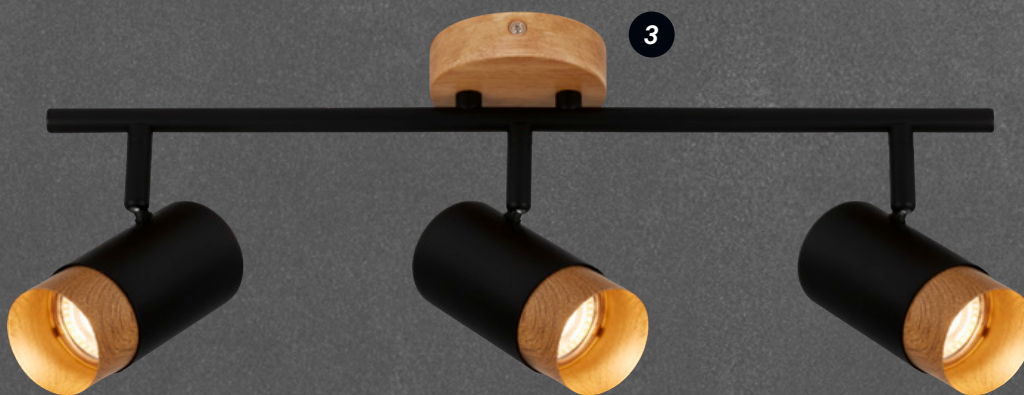
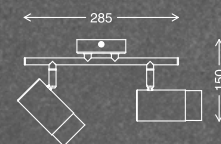
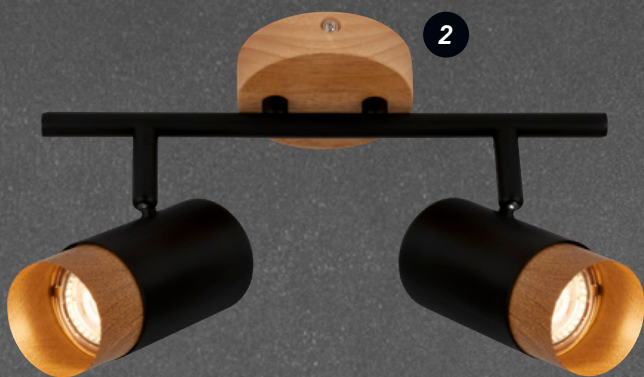

2 **2144025**
 schwarz/black/noir
 exkl. 2x LED GU10 max. 9W
 4002707445418

3 **2144035**
 schwarz/black/noir
 exkl. 3x LED GU10 max. 9W
 4002707445425

4 **2144045**
 schwarz/black/noir
 exkl. 4x LED GU10 max. 9W
 4002707445432

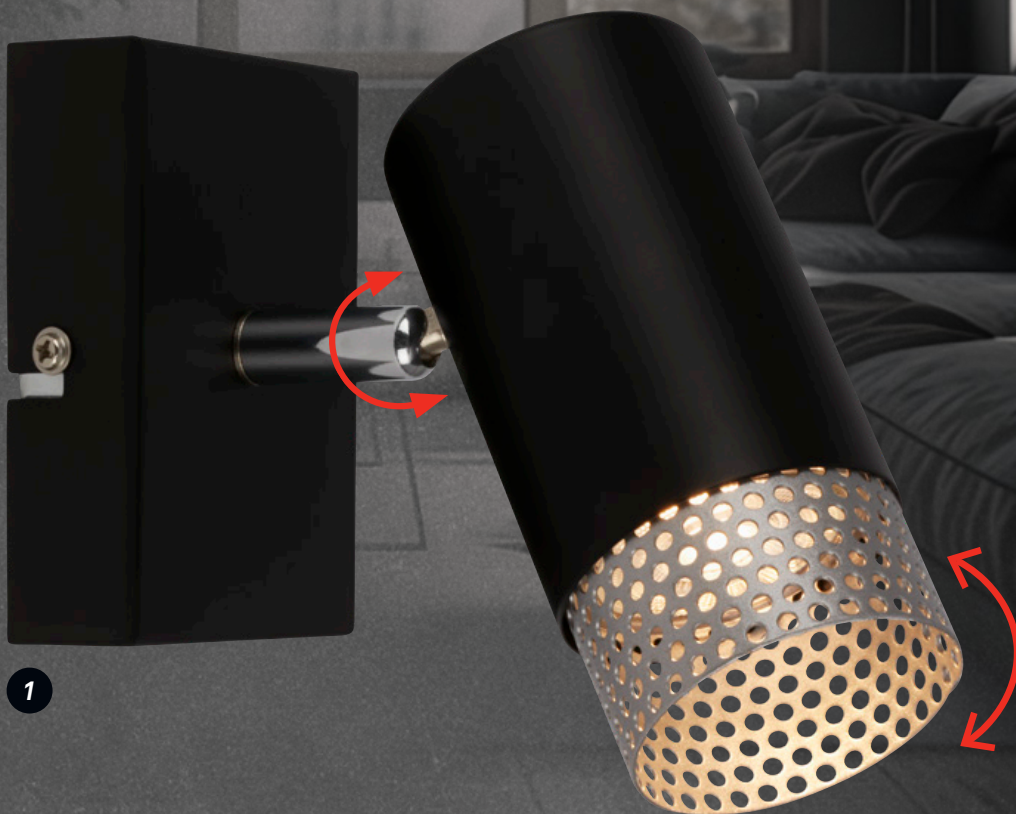
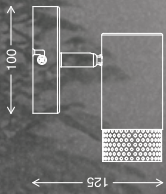
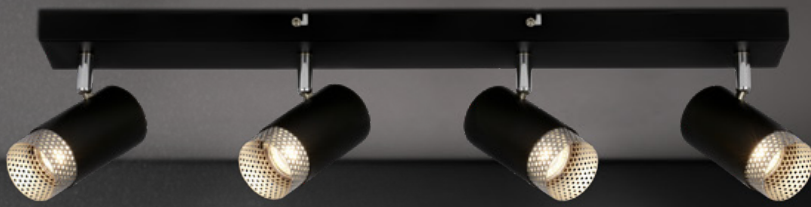

1

2142015

1

schwarz/black/noir

exkl. 1x LED GU10 max. 9W

4002707445364





2

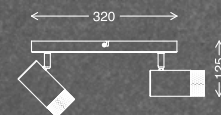

3

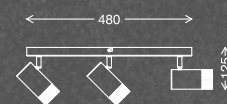

4



2

2142025

schwarz/black/noir

exkl. 2x LED GU10 max. 9W

4002707445371

3

2142035

schwarz/black/noir

exkl. 3x LED GU10 max. 9W

4002707445388

4

2142045

schwarz/black/noir

exkl. 14x LED GU10 max. 9W

4002707445395



2832015

1

schwarz/black/noir

exkl. 1x LED GU10 max. 9W

4002707459736



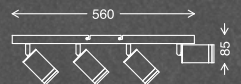
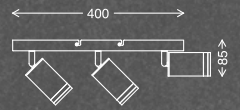
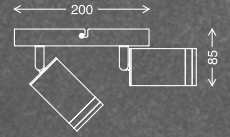

2

2832025

schwarz/black/noir

exkl. 2x LED GU10 max. 9 W

4002707459750

3

2832035

schwarz/black/noir

exkl. 3x LED GU10 max. 9 W

4002707459774

4

2832045

schwarz/black/noir

exkl. 4x LED GU10 max. 9 W

4002707459798



1

2832014

1

chrom-matt/chrome satin/
chrome mat
exkl. 1x LED GU10 max. 9 W

4002707459743



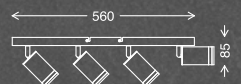
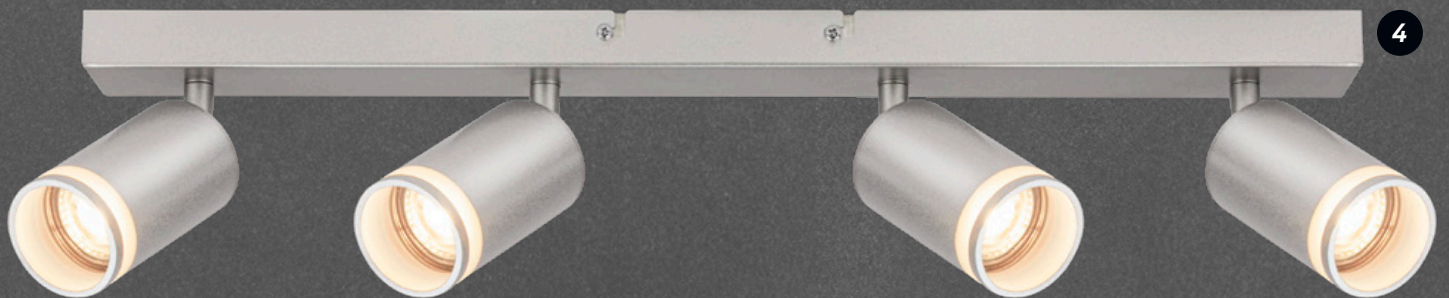
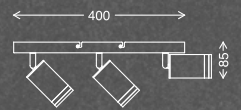
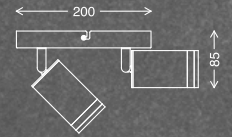

2 **2832024**

chrom-matt/chrome satin/
chrome mat
exkl. 2x LED GU10 max. 9 W

4002707459767

3 **2832034**

chrom-matt/chrome satin/
chrome mat
exkl. 3x LED GU10 max. 9 W

4002707459781

4 **2832044**

chrom-matt/chrome satin/
chrome mat
exkl. 4x LED GU10 max. 9 W

4002707459804

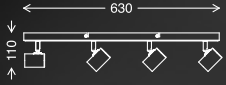

2222-044

1

antik-silber/antique-silver/
 argenté-antique
 excl. 4x E27 max. 60 W
 ohne Leuchtmittel/without bulb/
 sans ampoule

4002707423836



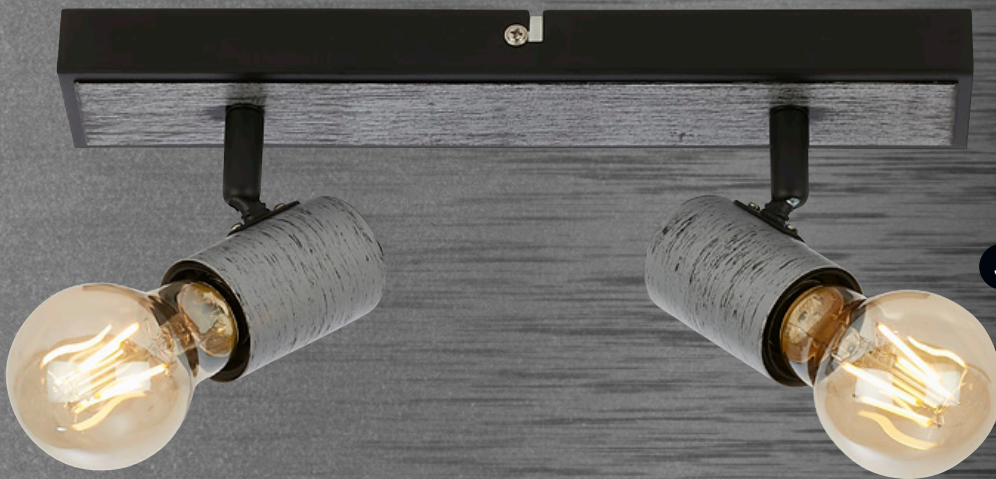
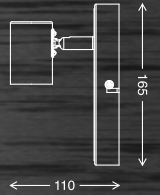

4

2 **2222-014**

*antik-silber/antique-silver/
argenté-antique
excl. 1x E27 max. 60 W
ohne Leuchtmittel/without bulb/
sans ampoule*

4002707423805

3 **2222-024**

*antik-silber/antique-silver/
argenté-antique
excl. 2x E27 max. 60 W
ohne Leuchtmittel/without bulb/
sans ampoule*

4002707423812

4 **2222-034**

*antik-silber/antique-silver/
argenté-antique
excl. 3x E27 max. 60 W
ohne Leuchtmittel/without bulb/
sans ampoule*

4002707423829



2926-045

1

schwarz/black/noir

inkl. 4x LED/GU10 4,9W 460 lm

3.000K

4002707422839

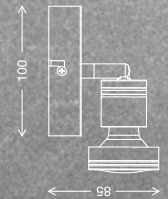

2 **2926-015**

schwarz/black/noir

*inkl. 1x LED/GU10 4,9W 460lm
3.000K
4002707422761*

3 **2926-025**

schwarz/black/noir

*inkl. 2x LED/GU10 4,9W 460lm
3.000K
4002707422792*

4 **2926-035**

schwarz/black/noir

*inkl. 3x LED/GU10 4,9W 460lm
3.000K
4002707422815*

PEARL/LONGA

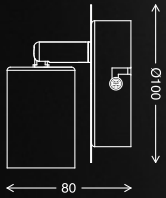

2868-015

1

schwarz/black/noir

*exkl. 1x E27 / max. 60 W
ohne Leuchtmittel/without bulb/
sans ampoule*

4002707366959



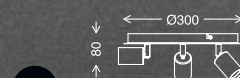
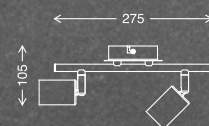
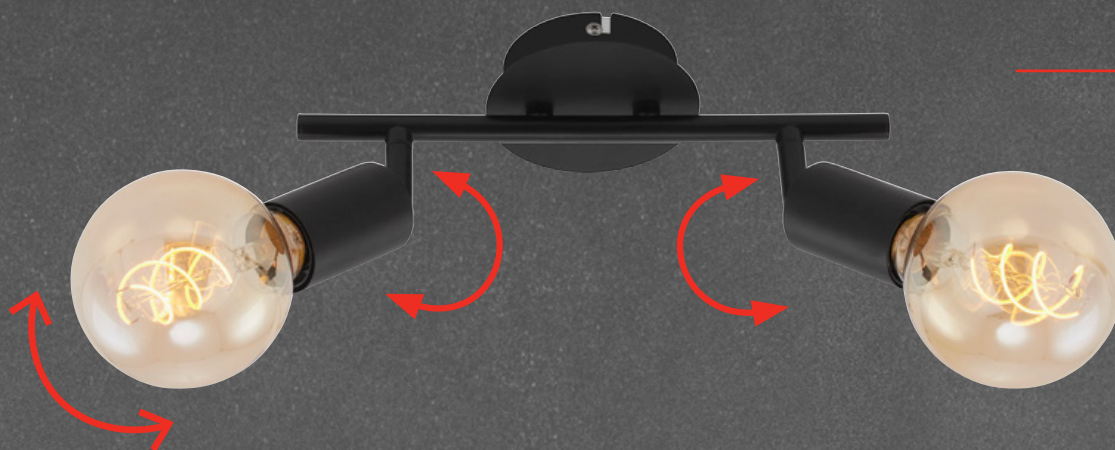

2 **2868-025**

schwarz/black/noir

*exkl. 2x E27 / max. 60 W
ohne Leuchtmittel/without bulb/
sans ampoule*

4002707366966

3 **2868-035**

schwarz/black/noir

*exkl. 3x E27 / max. 60 W
ohne Leuchtmittel/without bulb/
sans ampoule*

4002707366973

4 **2868-045**

schwarz/black/noir

*exkl. 4x E27 / max. 60 W
ohne Leuchtmittel/without bulb/
sans ampoule*

4002707366980

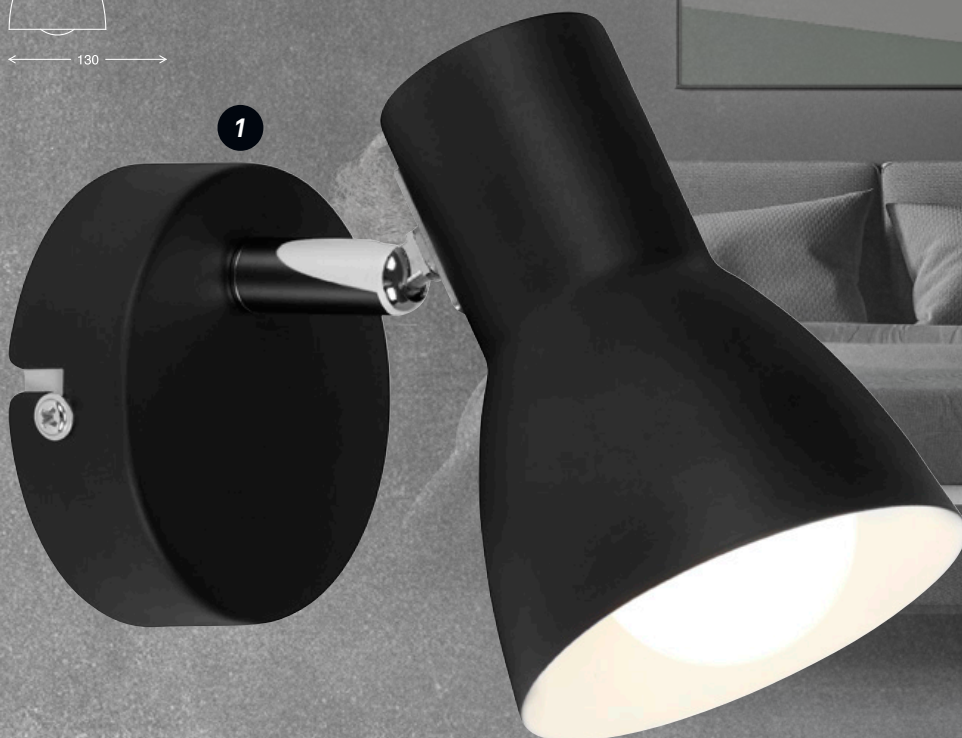
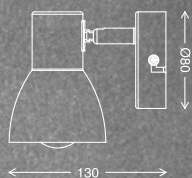
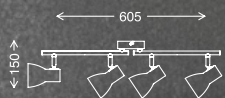
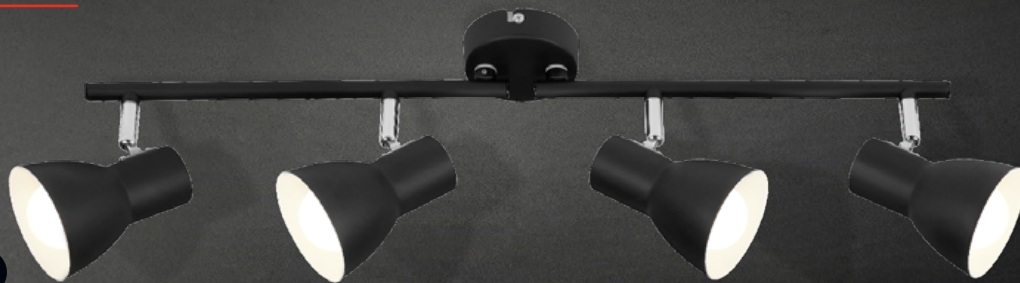

2860-015

1

schwarz/black/noir

exkl. 1x E14 / max. 25 W
ohne Leuchtmittel/without bulb/
sans ampoule

4002707366584

2860-045

2

schwarz/black/noir

exkl. 4x E14 / max. 25 W
ohne Leuchtmittel/without bulb/
sans ampoule

4002707366614



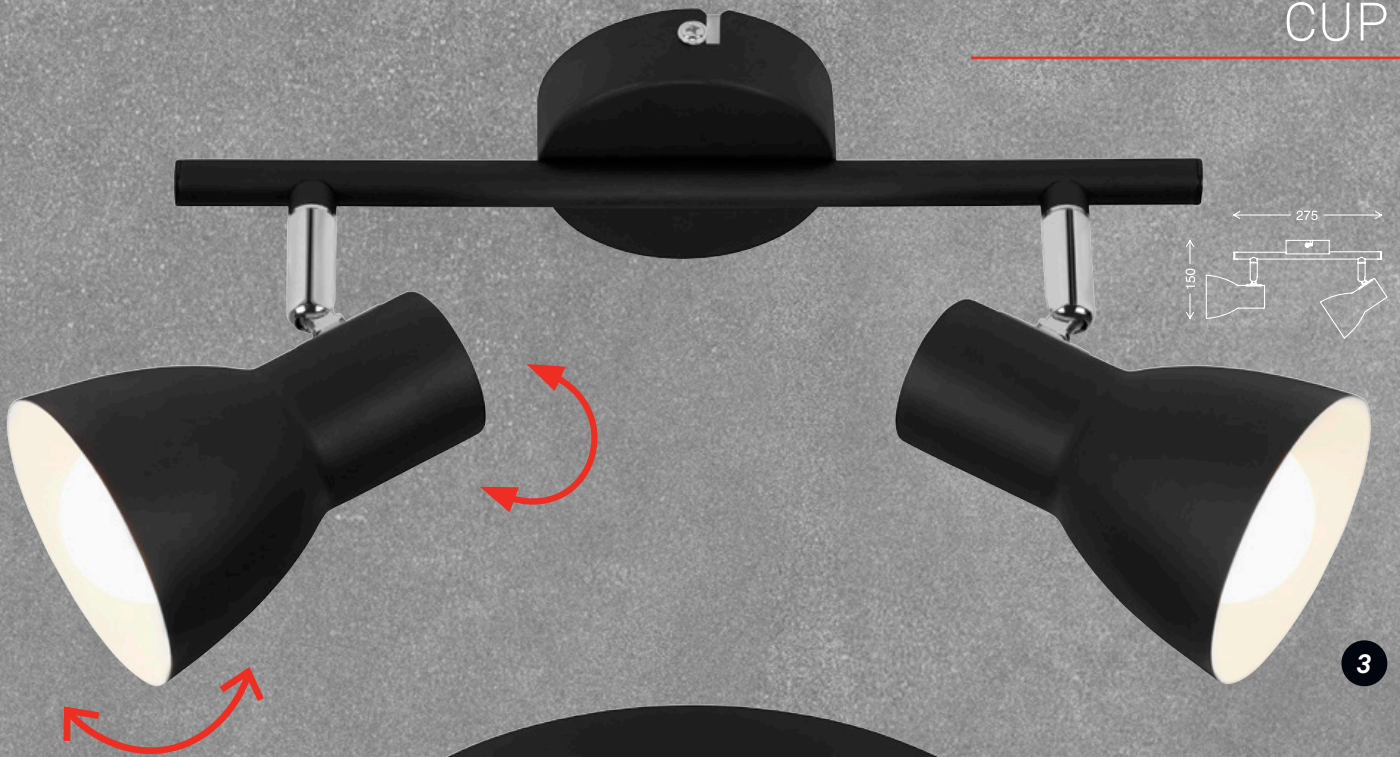

3



4

3 **2860-025**

schwarz/black/noir

*exkl. 2x E14 / max. 25W
ohne Leuchtmittel/without bulb/
sans ampoule*

4002707366591

4 **2860-035**

schwarz/black/noir

*exkl. 3x E14 / max. 25W
ohne Leuchtmittel/without bulb/
sans ampoule*

4002707366607

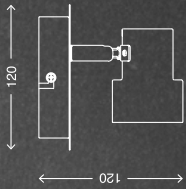

2861-016

1

weiß/white/blanc

inkl. 1x LED GU10 4,9W 460 lm
3.000K
4002707366676

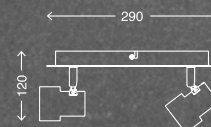
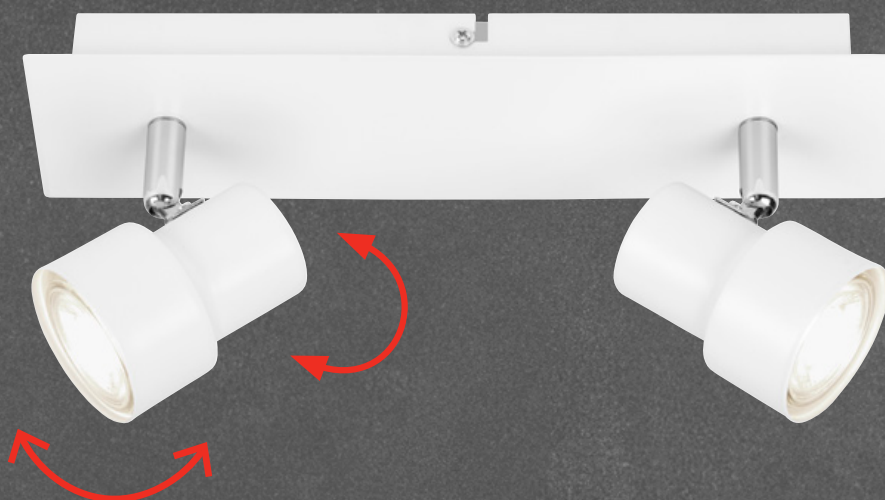

2 **2861-026**

weiß/white/blanc

inkl. 2x LED GU10 4,9 W 460 lm
3.000 K
4002707366683

3 **2861-036**

weiß/white/blanc

inkl. 3x LED GU10 5 W 460 lm
3.000 K
4002707366690

ROCK

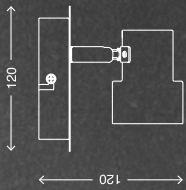

2861-015

1

schwarz/black/noir

*inkl. 1x LED GU10 4,9W 460 lm
3.000K
4002707366638*

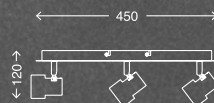
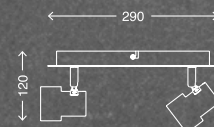
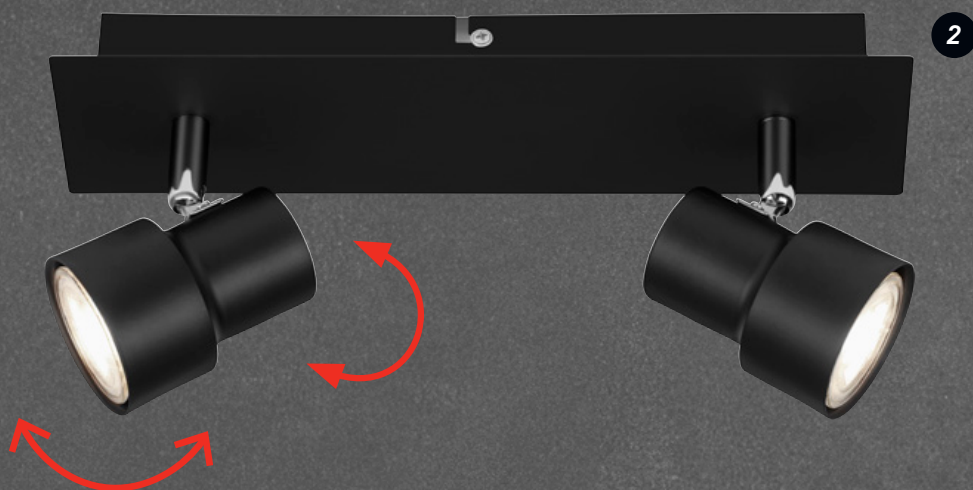

2 **2861-025**

schwarz/black/noir

inkl. 2x LED GU10 4,9 W 460 lm
3.000 K
4002707366645

3 **2861-035**

schwarz/black/noir

inkl. 3x LED GU10 4,9 W 460 lm
3.000 K
4002707366652

2

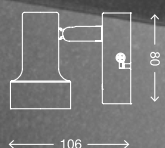
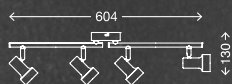

1



2843-012

1

*matt-nickel/satin nickel/
nickel mat*
inkl. 1x LED GU10 2,9 W 260 lm
3.000 K
4002707300960

2843-042

2

*matt-nickel/satin nickel/
nickel mat*
inkl. 4x LED GU10 2,9 W 260 lm
3.000 K
4002707301004

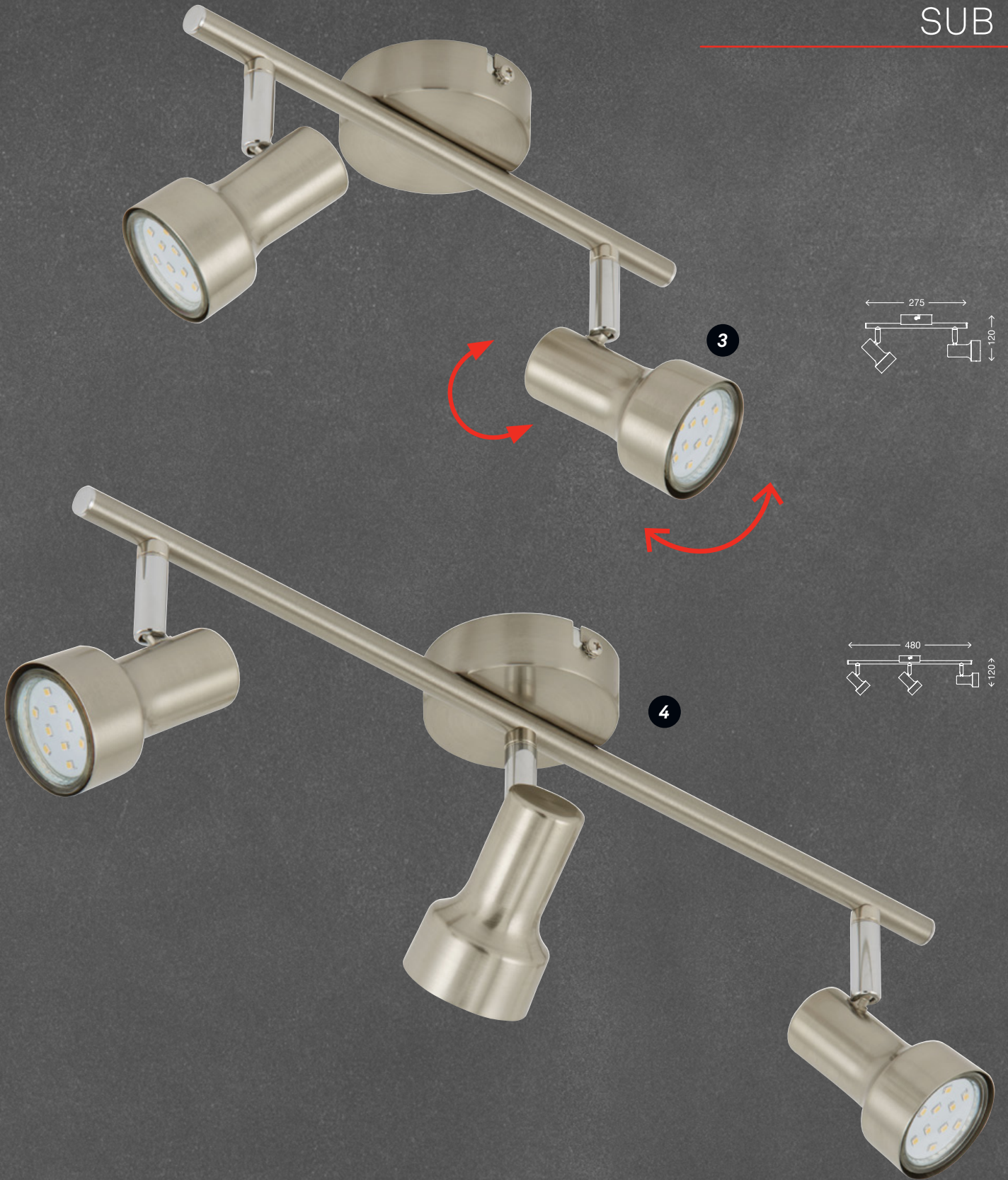

3 **2843-022**

*matt-nickel/satin nickel/
nickel mat*
inkl. 2x LED GU10 2,9 W 260 lm
3.000 K
4002707300984

4 **2843-032**

*matt-nickel/satin nickel/
nickel mat*
inkl. 3x LED GU10 2,9 W 260 lm
3.000 K
4002707300991

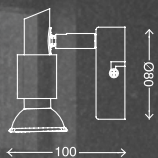

2907-012

1

*matt-nickel/satin nickel/
nickel mat*
inkl. 1x LED GU10 2,9W 260 lm
3.000K
4002707300441

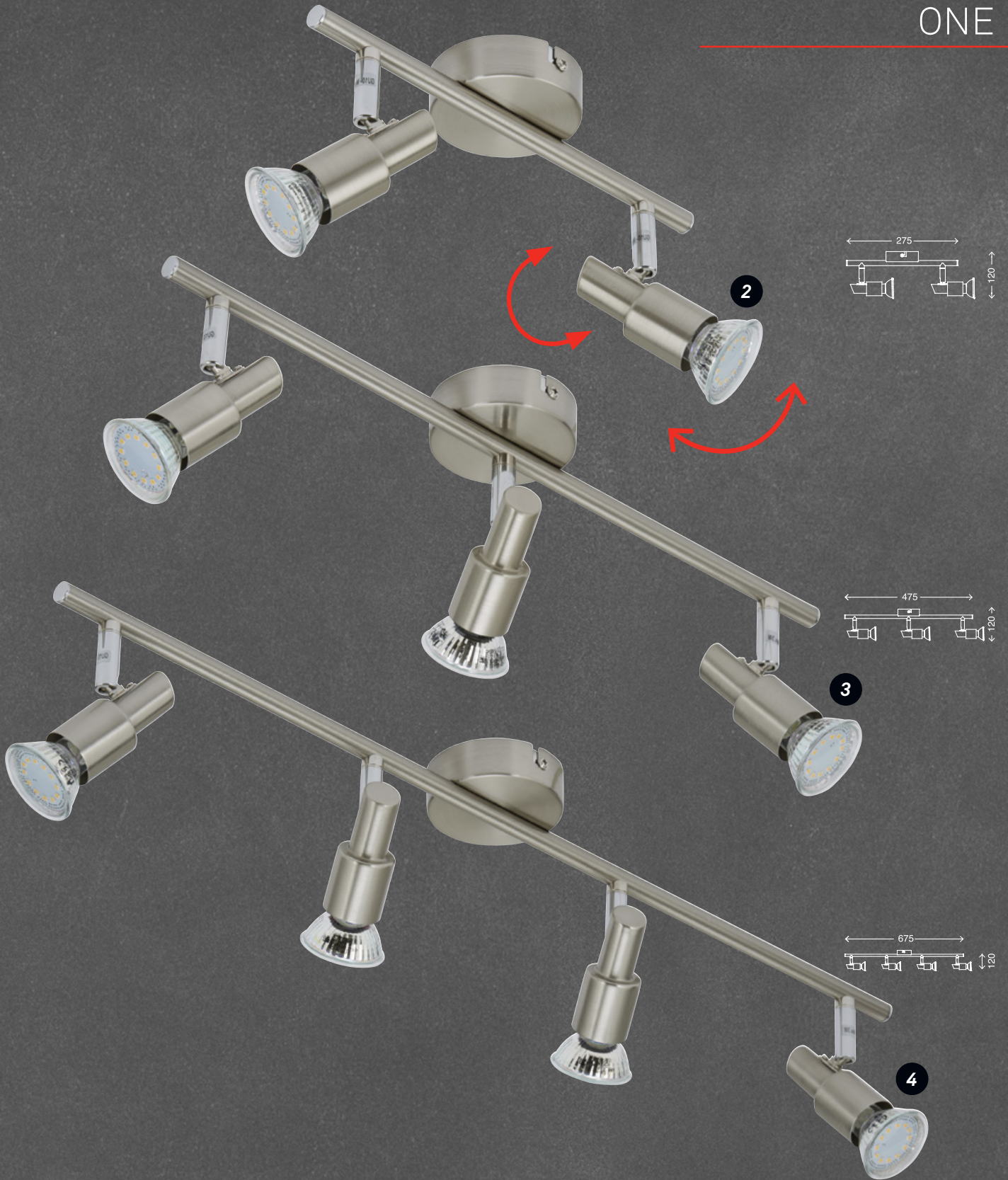

2 **2907-022**
 matt-nickel/satin nickel/
 nickel mat
 inkl. 2x LED GU10 2,9W 260lm
 3.000K
 4002707300458

3 **2907-032**
 matt-nickel/satin nickel/
 nickel mat
 inkl. 3x LED GU10 3 W 250 lm
 3.000K
 4002707300465

4 **2907-042**
 matt-nickel/satin nickel/
 nickel mat
 inkl. 4x LED GU10 3 W 250 lm
 3.000K
 4002707300472

SIMPLE

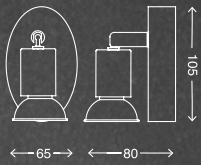

2767-016

1

weiß/white/bianco

inkl. 1x LED GU10 2,9 W 260 lm
3.000 K
4002707297529



2

2767-026

weiß/white/bianco

inkl. 2x LED GU10 2,9 W 260 lm
3.000 K
4002707297536

3

2767-036

weiß/white/bianco

inkl. 3x LED GU10 2,9 W 260 lm
3.000 K
4002707297543





SCHAURaum

SHOWROOM
SALLE D'EXPOSITION





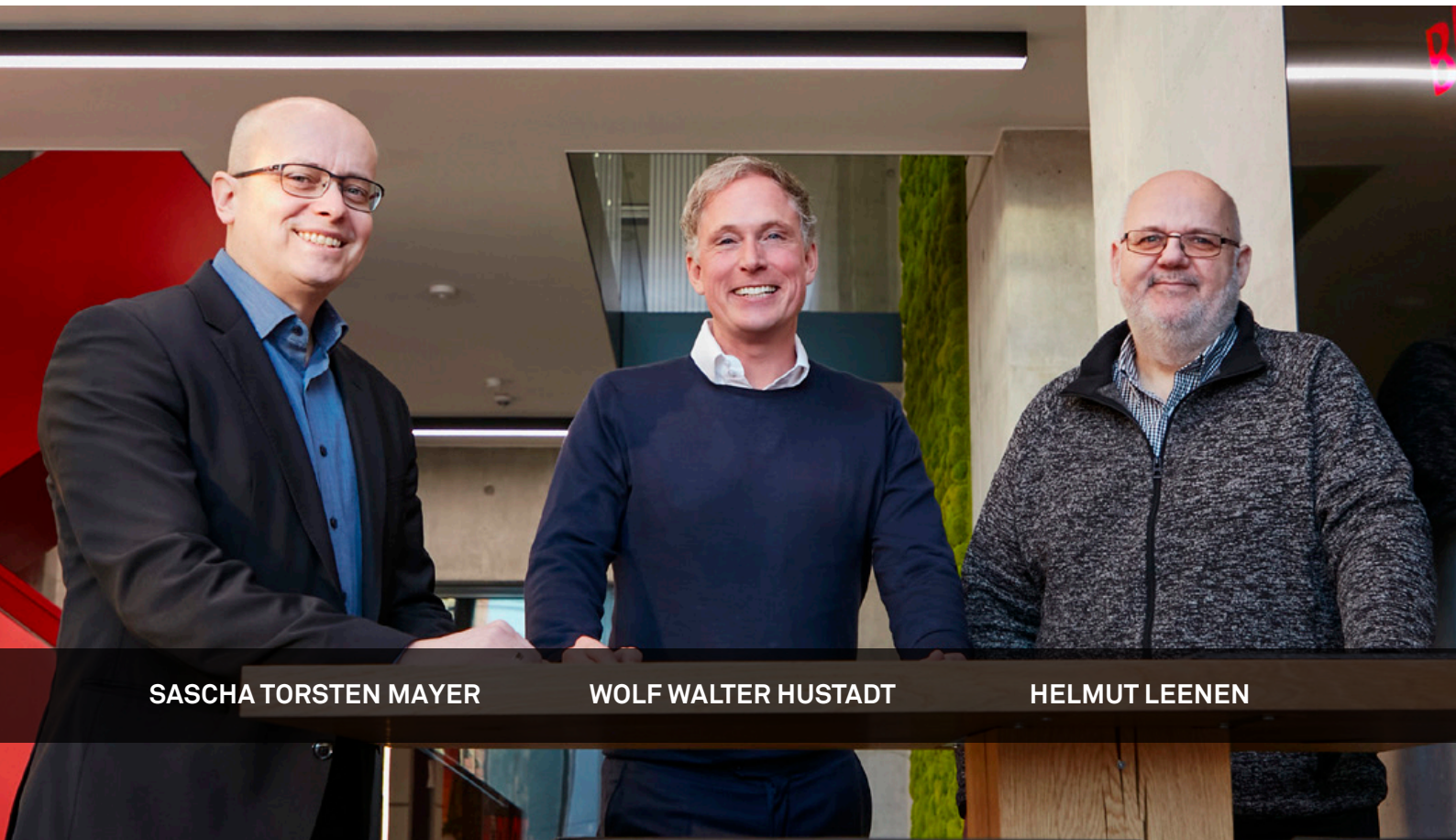

SASCHA TORSTEN MAYER

WOLF WALTER HUSTADT

HELMUT LEENEN

Als Familienunternehmen, geführt in der 2. Generation, fließen auch heute noch die Werte des Gründers in den Geschäftsalltag ein.

Darüber hinaus haben wir ein aktives Umweltmanagement etabliert und uns so der Umwelt verpflichtet. Denn: Für uns steht der Mensch im Vordergrund. Wir schaffen überzeugende Produkte für den Konsumenten und entwickeln diese gemeinsam mit unseren Kunden weiter. Dabei immer im Fokus: Die Bedürfnisse des Endverbrauchers - eben vom Leben inspiriert.*

As a family business, managed by the 2nd generation, the values of the founder still flow into everyday business today. In addition, we have established an active environmental management and are thus committed to the environment. Because for us, people are in the foreground. We create convincing products for consumers and develop them further together with our customers. Our focus is always on the needs of the end consumer - inspired by life.

En tant qu'entreprise familiale, dirigée par la deuxième génération, les valeurs du fondateur sont encore aujourd'hui intégrées dans le quotidien de l'entreprise. En outre, nous avons mis en place une gestion environnementale active et nous nous engageons ainsi en faveur de l'environnement. Car pour nous, les gens sont au premier plan. Nous créons des produits convaincants pour les consommateurs et les développons en collaboration avec nos clients. Avec toujours en ligne de mire : les besoins du consommateur final - inspirés par la vie.

*Aus Gründen der besseren Lesbarkeit wird bei Personenbezeichnungen und personenbezogenen Hauptwörtern in diesem Text die männliche Form verwendet. Entsprechende Begriffe gelten im Sinne der Gleichbehandlung grundsätzlich für alle Geschlechter. Die verkürzte Sprachform hat nur redaktionelle Gründe und beinhaltet keine Wertung.

„Bei **BRILONER** haben wir das Glück, mit einem großartigen Team über Teamwork und Intelligenz gemeinsam wachsen zu können. Dies ermöglicht uns, unsere Fähigkeiten maximal motiviert zusammen zu mobilisieren und für unsere Kunden das beste Ergebnis zu erzielen.“

Wolf Walter Hustadt
Inhaber & Geschäftsführer

„Teil der **BRILONER**-Familie zu sein erfüllt mich mit großer Dankbarkeit. Kundenorientierung ist DNA-Bestandteil der vielen Kolleginnen und Kollegen, die unser Unternehmen so erfolgreich machen. Wir lieben Herausforderungen und stellen uns diesen jederzeit mit vollem Einsatz.“

Helmut Leenen
Geschäftsführer Vertrieb & Marketing

„**BRILONER** ist ein inhabergeführtes Unternehmen mit klar definierter Wachstumsstrategie, einer kerngesunden finanziellen Basis, maximal kundenorientierten Prozessen, tollen Produkten und engagierten Menschen. Es erfüllt mich mit Stolz, Teil dieser DNA zu sein und Tag für Tag mit Leidenschaft **BRILONER** weiter voranzubringen.“

Sascha Torsten Mayer
CFO

POINT OF SALE

POINT OF SALE
POINT DE VENTE

Weil die Aktionsvermarktung unser Steckenpferd ist, haben wir auch für dieses Sortiment wieder tief in unsere Kreativkiste gegriffen. Verschiedene Display- und Warenträgergrößen runden das Sortiment ab und sorgen für eine ansprechende und erfolgreiche Vermarktung. Wir sehen uns auf der Fläche!

Because promotional marketing is our specialty, we have once again dug deep into our creative box when designing this range. Various display and merchandise stand sizes round off the range and ensure appealing and successful marketing. See you on the shop floor!

Le marketing promotionnel étant notre cheval de bataille, nous avons une fois de plus puisé dans notre boîte à idées pour cette gamme. Différentes tailles de présentoirs et de supports de produits complètent la gamme et assurent un marketing attrayant et performant. Rendez-vous en magasin !





BRILO[®]

by BRILONER

**Unser Tochterunternehmen
BRILO**
Der Spezialist für attraktive
Aktionsortimente

*Our subsidiary BRILO –
the specialist for attractive
promotional assortments*

*Notre filiale « BRILO » –
Le spécialiste des opérations
promotionnelles attractives*





ARTIKELVERZEICHNIS

PRODUCT DIRECTORY INDEX PRODUITS

ARTIKEL-NR ART-NO. NO ART.	SEITE PAGE PAGE	ARTIKEL-NR ART-NO. NO ART.	SEITE PAGE PAGE	ARTIKEL-NR ART-NO. NO ART.	SEITE PAGE PAGE	ARTIKEL-NR ART-NO. NO ART.	SEITE PAGE PAGE
1486-025	252	2113-018	144	2175016	179	2486-035	255
1759-011	250	2114-014	151	2176010	189	2491-012P	195
1851014	246	2114-015	139	2176015	188	2602-015	194
1853014	243	2114-016	151	2176016	188	2603-015	197
1854014	237	2115-015	138	2176019	189	2615-014P	191
1855014	233	2115-018	143	2178-012	177	2615-016P	191
2051-018	171	2116-014	164	2178-015	177	2689-034	204
2051-118	171	2116-015	155	2180-015	176	2689-035	204
2057-018	173	2117-014	164	2182015	139	2713-016P	197
2059-018	169	2121-014	165	2182018	143	2731-025	157
2062-018	169	2121-015	155	2189018	163	2731-035	157
2071-018	147	2131-014	165	2189118	163	2739-014P	194
2071-118	147	2142-015	294	2197026	166	2739-016P	194
2075-014	259	2142-025	295	2199-016	206	2762-015P	190
2080-012	182	2142-035	295	2222-014	301	2762-016P	190
2080-015	182	2142-045	295	2222-024	301	2763-016P	197
2080-016	182	2143-014	256	2222-034	301	2766014	192
2082-012	185	2144-015	292	2222-044	300	2766015	192
2082-015	185	2144-025	293	2251-034	205	2766016	192
2082-016	185	2144-035	293	2255-081	200	2767-016	316
2084-015	184	2144-045	293	2255-085	201	2767-026	317
2085-012	181	2148-028	172	2255-086	200	2767-036	317
2085-015	181	2150-112	68	2268-061	203	2790-015	193
2085-016	181	2151-224	70	2268-065	203	2790-016	193
2089-014	187	2152-224	70	2269-041	205	2794-010P	196
2089-015	187	2153-192	66	2272-016	207	2794-014P	196
2089-016	187	2154-192	66	2273-016	207	2794-016P	196
2090-025	153	2156-224	69	2274-016	206	2832014	298
2090-028	170	2157-448	71	2276-061	210	2832015	296
2104-015	137	2158-384	67	2276-065	211	2832024	299
2104-018	148	2160-000	65	2276-066	210	2832025	297
2104-115	137	2165-192	72	2277-021	209	2832034	299
2104-118	149	2166-192	72	2278-031	209	2832035	297
2105-018	149	2167-384	73	2280-014	202	2832044	299
2110-018	167	2171-015	64	2281-014	202	2832045	297
2110-118	167	2171-019	64	2360-016	160	2843-012	312
2111-018	145	2175012	179	2486-015	255	2843-022	313
2111-118	145	2175015	178	2486-025	255	2843-032	313

ARTIKEL-NR ART-NO. NO ART.	SEITE PAGE PAGE	ARTIKEL-NR ART-NO. NO ART.	SEITE PAGE PAGE	ARTIKEL-NR ART-NO. NO ART.	SEITE PAGE PAGE	ARTIKEL-NR ART-NO. NO ART.	SEITE PAGE PAGE
2843-042	312	3248-012	226	3816014	220	3996-025	126
2860-015	306	3248-018	227	3817014	220	3996-026	127
2860-025	307	3257-029	228	3818014	221	3996-035	126
2860-035	307	3258-029	229	3820414	150	3996-036	127
2860-045	306	3259-029	228	3820415	135	4075-034	259
2861-015	310	3351-015	134	3839014	218	4075-054	258
2861-016	308	3351-016	141	3840014	218	4143-034	257
2861-025	311	3351-216	141	3841014	219	4143-054	257
2861-026	309	3360-016	140	3842014	216	4486-035	252
2861-035	311	3390-014	270	3843014	216	4486-045	253
2861-036	309	3390-015	270	3844015	268	4759-011	248
2868-015	304	3391-014	271	3845015	268	4759-031	249
2868-025	305	3391-015	271	3846015	269	4768-015	215
2868-035	305	3403-015	152	3847014	267	4842014	217
2868-045	305	3403-018	158	3847015	267	4851014	246
2892-016P	195	3403-118	159	3848014	266	4851034	244
2901-015	261	3404-016	161	3848015	266	4853014	241
2901-025	261	3404-116	161	3851014	246	4853034	242
2901-035	261	3456-015	289	3853014	242	4854014	238
2901-045	260	3456-215	289	3854014	238	4854034	239
2907-012	314	3465-415	276	3855014	235	4855014	234
2907-022	315	3466-415	286	3910-035	54	4855034	232
2907-032	315	3467-415	284	3912-032	50	7034-034	109
2907-042	315	3468-415	282	3913-032	50	7034-035	109
2920-015	263	3504-018	225	3914-032	51	7034-036	109
2920-035	263	3759-011	251	3915-032	51	7035-034	108
2920-045	262	3768-015	214	3916-032	52	7035-035	108
2926-015	303	3769-015	214	3917-032	52	7035-036	108
2926-025	303	3784-015	34	3918-035	49	7036-034	92
2926-035	303	3784-016	34	3919-035	49	7036-035	92
2926-045	302	3785-015	31	3920-035	54	7036-036	92
2992-015	139	3785-016	31	3921-015	55	7043-039	98
2992-018	142	3786-015	36	3922-034	53	7044-034	89
2992-028	142	3786-016	36	3923-034	53	7044-035	89
2992-038R	142	3787-015	33	3924-015	55	7044-036	89
3107-012	224	3787-016	33	3925-032	46	7046-014	93
3108-018	224	3788-015	32	3926-032	47	7046-016	93
3118-018	222	3788-016	32	3927-035	48	7046-034	93
3131-018	223	3793-014	35	3928-035	48	7046-035	93
3136-018	222	3793-015	35	3929-015	37	7046-036	93
3165-029	229	3795-014	30	3930-015	37	7047-034	90
3222-012	226	3795-015	30	3996-015	126	7047-035	90
3222-018	226	3815014	220	3996-016	127	7047-036	90

ARTIKELVERZEICHNIS

PRODUCT DIRECTORY
INDEX PRODUITS

ARTIKEL-NR ART-NO. NO ART.	SEITE PAGE PAGE	ARTIKEL-NR ART-NO. NO ART.	SEITE PAGE PAGE	ARTIKEL-NR ART-NO. NO ART.	SEITE PAGE PAGE	ARTIKEL-NR ART-NO. NO ART.	SEITE PAGE PAGE
7048-034	96	7125-434	120	7586032	85	7994016	128
7048-035	96	7125-435	120	7586035	85	7995016	128
7048-036	96	7125-436	120	7586036	85	8018147	22
7049-014	117	7132-014	281	7587032	84	8019147	23
7049-015	117	7132-414	280	7587035	84	8020294	20
7049-016	117	7141-014	279	7587036	84	8021294	21
7052-016	129	7141-016	279	7588032	87	8022252	18
7053-034	116	7141-414	278	7588035	87	8023252	19
7053-035	116	7141-416	278	7588036	87	8024005	17
7053-036	116	7142-014	285	7589032	86	8024006	17
7057-434	111	7142-414	284	7589035	86	8043005	16
7057-435	111	7143-014	283	7589036	86	8043006	16
7057-436	111	7143-414	282	7597-034	110		
7110-032	102	7146-034	97	7597-035	110		
7110-035	102	7146-035	97	7597-036	110		
7110-036	102	7146-036	97	7598-032	114		
7110-037	102	7147-035	103	7598-036	114		
7110-039	102	7147-036	103	7602-034	88		
7113-432	119	7147-038	103	7602-035	88		
7113-435	119	7147-039	103	7602-036	88		
7113-436	119	7181-032	105	7605-032	91		
7114-412	121	7181-035	105	7605-036	91		
7114-416	121	7181-036	105	7606-034	95		
7114-432	121	7225-038	104	7606-035	95		
7114-435	121	7225-039	104	7606-036	95		
7114-436	121	7282-012	118	7759-011	251		
7115-432	115	7282-016	118	7851014	247		
7115-435	115	7282-032	118	7853014	242		
7115-436	115	7282-036	118	7854014	238		
7117-014	276	7284-012	113	7855014	234		
7117-414	277	7284-016	113	7990014	124		
7118-014	287	7284-032	113	7990015	124		
7118-414	286	7284-036	113	7990016	124		
7122-014	275	7480-019	99	7991014	124		
7122-016	275	7481-019	99	7991015	124		
7122-414	274	7482-019	99	7991016	124		
7122-416	274	7486-015	253	7992036	123		
7125-416	120	7487-015	256	7993036	123		



QUALITÄT, UMWELT & SICHERHEIT

QUALITY, ENVIRONMENT & SAFETY
QUALITÉ, ENVIRONNEMENT ET SÉCURITÉ

Um einen hohen Qualitätsstandard unserer Produkte und Dienstleistungen zu garantieren und stetig zu verbessern, setzt unser Unternehmen auf das Total Quality Management nach der DIN-ISO 9001:2015. Darüber hinaus werden alle Produkte der CE-Prüfung unterzogen und entsprechen somit allen europäischen Anforderungen an die Produktsicherheit.

In order to be able to guarantee and continuously improve the high quality standard of our products and services, our company relies on total quality management in accordance with DIN-ISO 9001:2015. In addition, all products undergo CE testing and thus comply with all European product safety requirements.

Pour garantir la norme qualité élevée de nos produits et services, et ne jamais cesser de les améliorer, notre entreprise se conforme à la notion de « Total Quality Management » (qualité totale) selon la norme DIN-ISO 9001:2015. En outre, l'ensemble des produits sont soumis à une certification CE et répondent ainsi à toutes les exigences européennes en termes de sécurité des produits.



IMMER UP TO DATE - NEUE RICHTLINIE EU 2017/1369

Auf die neue Richtlinie sind wir bestens vorbereitet. Ab dem 01.09.2021 wird unsere komplette Ware, welche wir in die EU einführen den neuen Richtlinien entsprechen und die Verpackungen entsprechend ausgezeichnet sein. Ebenfalls erfüllen wir alle weiteren Anforderungen der neuen Rahmenverordnung.

We are completely prepared for the new directive. Starting from 01.09.2021, all goods that we import into the EU will comply with the new directives and the packaging will be labelled accordingly. We also fulfil all other requirements of the new framework regulation.

Nous sommes bien préparés à la nouvelle directive. À partir du 01.09.2021, tous nos produits importés dans l'UE seront conformes aux nouvelles directives et les emballages seront étiquetés en conséquence. Nous répondons également à toutes les autres exigences du nouveau règlement-cadre.

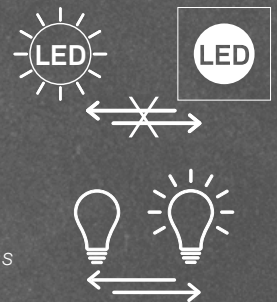

ecovadis

...steht für sustainable supply management und bewertet das nachhaltige Handeln von Unternehmen. Seit 2021 nehmen wir an diesem Bewertungsprogramm teil und lassen seitdem unsere Anstrengungen in den Bereichen Umweltschutz, Arbeits- und Menschenrechte, Ethik sowie nachhaltige Beschaffung bewerten. Diese schon sehr positive Bewertung lädt uns nicht zum Ausruhen ein; wir haben es uns zur Aufgabe gemacht, die genannten Bewertungskriterien fest in unserer Unternehmenskultur zu verankern und stetig zu verbessern.



Als Mitglied des BSCI treten wir für eine nachhaltige Einhaltung von Sozialstandards in unserer Lieferkette ein. Wir folgen den Regeln einer fairen und ehrlichen Partnerschaft.

As a member of the BSCI, we advocate for sustainable compliance with social standards in our supply chain. We abide by the rules of fair and honest partnership.

En tant que membre de la BSCI, nous nous engageons en faveur d'un respect durable des standards sociaux de notre chaîne de livraison. Nous appliquons un partenariat franc et équitable.



GARANTIEERKLÄRUNG

WARRANTY
CONDITIONS DE GARANTIE

DE Die Bedingungen unserer Herstellergarantie finden Sie unter:

GB You can also find the manufacturer's warranty conditions at:

FR Ces conditions de notre garantie de fabricant peuvent être également téléchargées en allant sur:

www.briloner.com/herstellergarantie

KONTAKT

CONTACT

Deutschland/Zentrale

Briloner Leuchten GmbH & Co. KG
Am Steinbach 14
D-59872 Meschede
T +49 (0) 291 952993 101
F +49 (0) 291 952993 109
E mail@briloner.com
www.briloner.com

Spanien/Portugal

Briloner Iberica S.L.
José Manuel Golvano (ESP)
Nuno Santos (PRT)
C/ Marqués del Riscal, 11
E-28010 Madrid
T +34 936476421
E j.golvano@briloner.com (ESP)
E n.santos@briloner.com (PRT)

Finnland

Heat Finland Oy
Jouko Posti
Lotankatu 1, LH2
02680 Espoo
T +358 400 414624
E jouko.posti@heat-finland.fi

e.lite
Hannu Ripatti
Kanervistontie 1
45200 Kouvola
T +358 400 250700
E info@e.litevalaisiment.fi

Österreich

Briloner Leuchten GmbH & Co. KG
Am Steinbach 14
D-59872 Meschede
T +49 (0) 291 952993 101
F +49 (0) 291 952993 109
E mail@briloner.com

Benelux

Briloner Leuchten GmbH & Co. KG
Raymond Hoogendoorn
Am Steinbach 14
D-59872 Meschede
T +31 6 21838435
E r.hoogendoorn@briloner.com

Bulgarien

Electro Style ood
Grigor Milanov
Ostretz 33 str
BG-1505 Sofia
T +359 888 320 558
E grigor.milanov@electrosyle.bg

Schweiz

Briloner Leuchten GmbH & Co. KG
Am Steinbach 14
D-59872 Meschede
T +49 (0) 291 952993 101
E mail@briloner.com

Polen

Briloner Polska Sp. z o.o.
Ul. Przechłkowska 324
02-962 Warszawa / Polska
Rafal Fliszewski
T +48 606 488 226
E r.fliszewski@briloner.com

Norwegen/Schweden/

Dänemark

More Trade Syd AB
Axel Teméus
Metallgatan 21 B
SE- 262 72 Ängelholm
T +46 431 200 17
E a.terneus@m-trade.se

Frankreich

Briloner France sàrl
Laurent Fillette
7 Place de la Gare
F-57200 Sarreguemines
T +33 (0) 3 88 75 55 91
E c.stroh@briloner.com

Kroatien/Slowenien

Lumen d.o.o.
Bogo Hmelina
Jezev dol 18
SLO-2319 Poljcane
T +386 2 8290050
E lumen@lumen.si

Italien

Briloner Italia s.r.l.
Stefano Castello
Vittorio Peluso
Corso Di Porta Vigentina 35
I-20122 Milano
F-57200 Sarreguemines
T +39 (0423) 420905
E c.milia@briloner.com

Slowakei/Tschechien

Ing. Michal Pernicka
T +420 731 314 281
E info.briloner@seznam.cz

Rumänien

Ionut Chitulescu
T +40 730512514
E i.chitulescu@briloner.com

Ungarn

Gyula Bresák
T +36 204145258
E bresak@merchandiy.hu

International

Briloner Leuchten GmbH & Co. KG
Nathalie Cronenberg
Am Steinbach 14
D-59872 Meschede
T +49 (0) 291 952993 101
M +49 (0) 171 1156704
E n.cronenberg@briloner.com

ZEICHENERKLÄRUNG

SIGNS AND SYMBOLS LÉGENDE

Sternenhimmel Effekt

Starlight effect
Ciel étoilé effet



Backlight Effekt

Backlight Effect
Effet de rétroéclairage



Brilo Bad

Brilo Bath
Brilo Bain



Briloner Splash

Briloner Splash
Briloner Splash



Lero Innen

Lero Indoor
Lero à l'intérieur



Lero Außen

Lero Outdoor
Lero extérieur



Komfort Licht

Comfort light
Lampes de chevet



Living Nature

Living Nature
Living Nature



Wood&Style

Wood&Style
Bois&Style



Silver Crafted

Silver crafted
Silver crafted



Black Steel

Black Steel
Acier noir



Memoryfunktion

Memory function
Fonction mémoire



Schalter

Switch
Interrupteur



Kabelschalter

Cable switch
Commutateur de câble



Bewegungssensor

Motion detector
Détecteur de mouvement



Tageslichtsensor

Daylight sensor
Capteur crépusculaire



Drucksensor

Push switch
Interrupteur poussoir



Tastsensor

Touch sensor
Capteur tactile



Leuchtdauer

Illumination time
Temps d'éclairage



Batterie inklusive

Battery inclusive
Pile inclus



Montagematerial inklusive

Mounting material inclusive
Matériel de montage inclus



Drehbar

Rotatable
Rotatif



Schwenkbar

Pivotable
Orientable



Warmweiß

Warmwhite
Blanc chaud



Neutralweiß

Neutral white
Blanc neutre



Tageslicht

Daylight
Lumière du jour



Warmweißwechsel

Dim to warm
Changement de blanc chaud



Farbtemperaturwechsel

Correlated color temperature
Température de couleur corrélée



Farbwechsel

Colour change
Changement de couleurs



Dimmbar via FB

Dimmable via remote control
Dimmable par télécommande



Stufendimmbar

Dimmable in steps
Variable par palier



IP Schutzklasse

IP-rating
Indice de protection



Timerfunktion

Timer function
Fonction minuterie



Nachtlichtfunktion

Nightlight function
Fonction veilleuse



Kristalloptik

Crystal optic
Décor cristal



BRILONER[®]

Light. Inspired by life.

www.briloner.com

Briloner Leuchten GmbH & Co. KG
Am Steinbach 14 · D-59872 Meschede